

Features

Low Harmonic Content

Provides clean power for the farm and home.

Cast-Iron Gearcase with Helical Gears

A 540 RPM operating speed easily pairs with most tractors.

Premium Square D Circuit Breakers

Square D is the industry leader in circuit breaker protection.

Frequency Meter

A large 3 1/2" frequency meter ensures the proper output.

Protective PTO Shield

Safety is always a priority.

4-Wire Anderson Full Power Plug Included

You supply the 4/0 THHN, we provide the plug.

100% Load Tested

No statistical sampling here. We load test every generator before it leaves our facility.

POWER TAKE-OFF

69,000 Continuous Watts
540 RPM

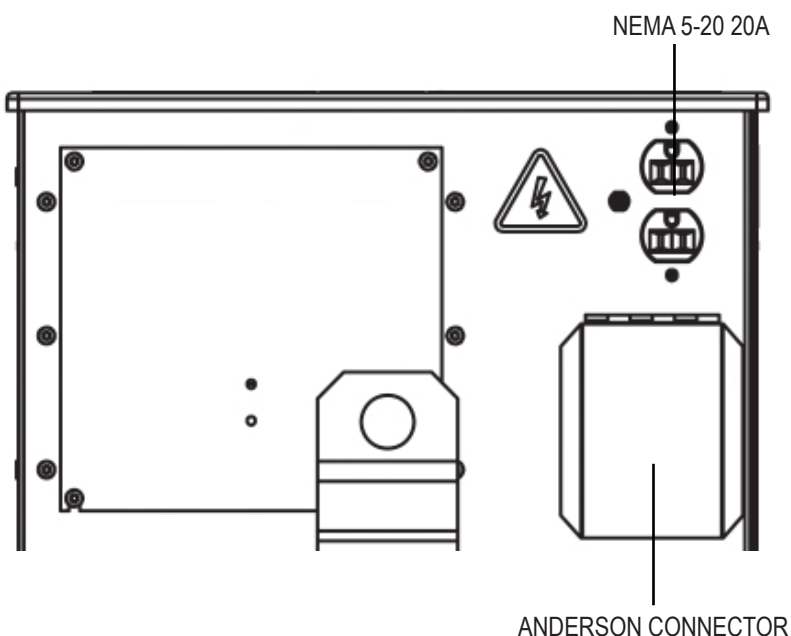
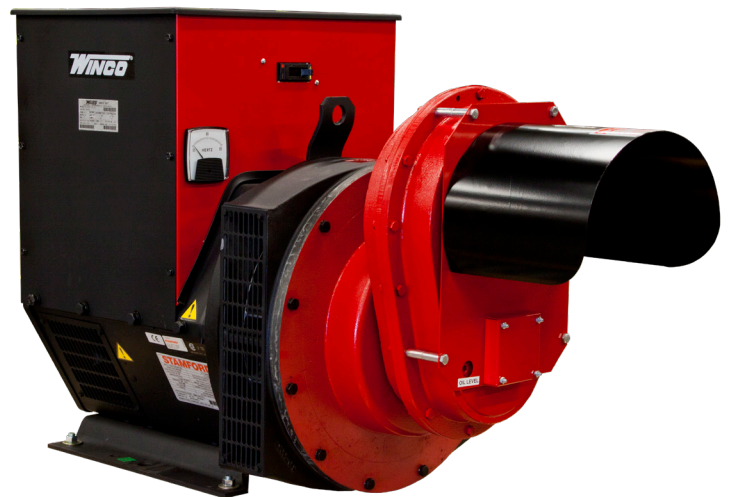

Optional Accessories

PTO Drive Shafts

1 3/4" - 20 spline x 1 3/4" - 20 spline quick connect shafts. Designed to handle the required horsepower ratings.

Off-Road PTO Trailer

Our steel trailers are specifically engineered for the torque of running this PTO generator.

Manual Transfer Switch

Set up your generator quickly and safely to restore power to critical circuit breakers.

W85FPTOS

CONTINUOUS WATTS	69,000
AMPS ⁽¹⁾	287
OUTPUT	120/240V
PHASE	SINGLE
PTO INPUT SPEED	540 RPM
INPUT SHAFT SIZE	1 3/4" - 20 SPLINE
REQUIRED INPUT HP ⁽²⁾	138
MOTOR STARTING ⁽³⁾	25 HP
FREQUENCY METER	YES
MAIN CIRCUIT BREAKER	300 AMP
BONDED NEUTRAL	YES
GROUND LUG	YES
GEARCASE OIL	SAE 85W 90-140
GEARCASE OIL CAPACITY	2.75 PINTS
LIFTING EYE	YES
WARRANTY	3 YRS

NOTES: (1) Unity (1.0) power factor (2) Required HP at PTO of tractor for full rated output. Each 2 HP of tractor power equals approximately 1 kW of electric power. (3) Code G capacitor start motor. Please consult factory or authorized dealer for further information.

GENERATOR END

VOLTAGE REGULATION	+/- 5%
TOTAL HARMONIC DISTORTION	< 5%
RATING	150° C
TYPE	4 POLE ROTATING FIELD
BRUSHLESS	YES
GENERATOR SPEED	1800 RPM
VOLTAGE CONTROL	AVR AS440
INSULATION	CLASS H

RECEPTACLES

120 VOLT RECEPTACLES	(1) NEMA 5-20 20A DUPLEX
120/240 VOLT ANDERSON	350 AMPS

SHIPPING

DIMENSIONS (LxWxH)	46.7" x 17.5" x 26.8"
NET WEIGHT	972 LBS
SHIPPING DIMENSIONS	55.25" x 28.5" x 32.25"
SHIP WEIGHT	982 LBS
FREIGHT CLASS	65

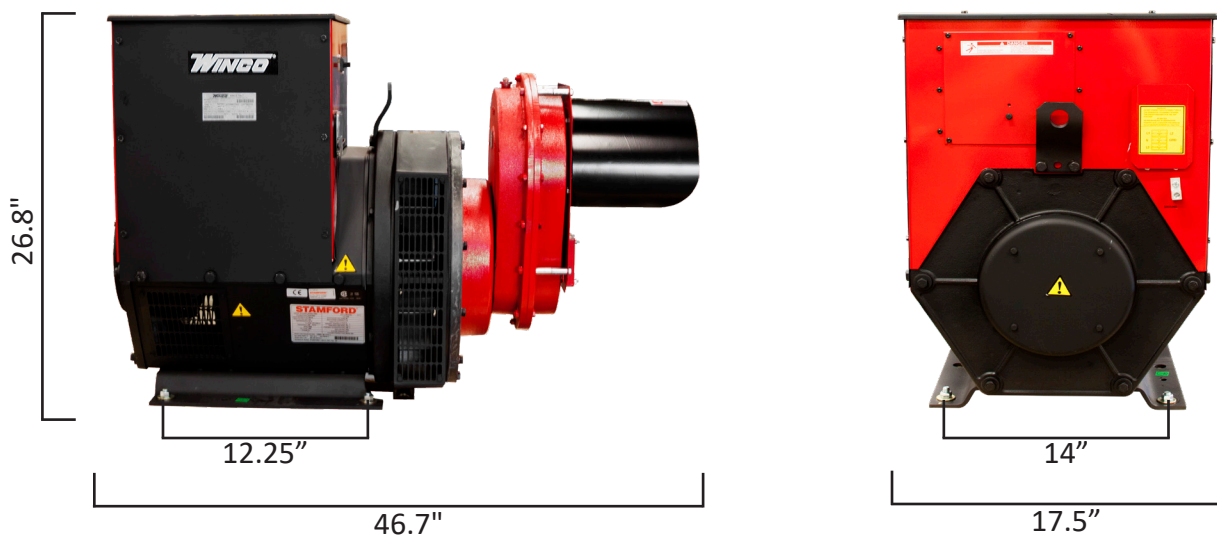

Specifications are subject to change without notice.