

P12040

For model: P12040

Smoke Alarm User's Guide

**AC Wire-in Single and/or Multiple Station (up to 24 Devices)
Photoelectric Smoke Alarm with 9 Volt Battery Back Up and
"HUSH" Control to temporarily silence nuisance alarms.**

Thank you for purchasing this smoke alarm. It is an important part of your family's home safety plan. You can trust this product to provide the highest quality safety protection. We know you expect nothing less when the lives of your family are at stake. Kidde alarms and accessories **CAN ONLY BE** interconnected with other Kidde alarms and accessories as well as specified brands and models of interconnect compatible alarms. Connection of Kidde products to a non-specified manufacturer's interconnect system, or connection with non-specified equipment from another manufacturer into an existing Kidde system could result in nuisance alarming, failure to alarm, or damage to one or all of the devices in the interconnect system. Refer to the User's Guide supplied with each Kidde product for interconnect compatible models, brands, and devices. Refer to the wiring instructions in section 3 for NFPA initiating device limits.

For your convenience, write down the following information. If you call our Consumer Hotline, these are the first questions you will be asked.

<i>Smoke Alarm Model Number (located on back of alarm):</i>	
<i>Date Code (located on back of alarm). National Fire Protection Association (NFPA) and the manufacturer recommends replacing this alarm ten years from the date code:</i>	
<i>Date of Purchase:</i>	
<i>Where Purchased:</i>	



21008164-EN Rev A
1375-7213-00

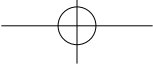

WARNING! BATTERY DOOR WILL NOT CLOSE UNLESS A BATTERY IS PRESENT. REMOVAL OF THE SMOKE ALARM BATTERY AND DISCONNECTING OR LOSS OF AC POWER WILL RENDER THE SMOKE ALARM INOPERATIVE.

ELECTRICAL RATING: 120 VAC, 60HZ, 80mA maximum per alarm (maximum 80mA for originating unit with 24 devices interconnected).

CONTENTS OF THIS MANUAL

- 1 -- RECOMMENDED LOCATIONS FOR SMOKE ALARMS**
- 2 -- LOCATIONS TO AVOID**
- 3 -- INSTALLATION INSTRUCTIONS**
- 4 -- OPERATION AND TESTING**
- 5 -- NUISANCE ALARMS**
- 6 -- MAINTENANCE**
- 7 -- LIMITATIONS OF SMOKE ALARMS**
- 8 -- GOOD SAFETY HABITS**
- 9 -- NFPA PROTECTION STANDARD 72**
- 10 -- CALIFORNIA STATE FIRE MARSHAL REQUIRED INFORMATION**
- 11 -- SERVICE AND WARRANTY**

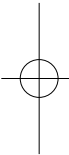

1. RECOMMENDED LOCATIONS FOR ALARMS

- Locate the first alarm in the immediate area of the bedrooms. Try to monitor the exit path as the bedrooms are usually farthest from the exit. If more than one sleeping area exists, locate additional alarms in each sleeping area.
 - Locate additional alarms to monitor any stairway as stairways act like chimneys for smoke and heat.
 - Locate at least one alarm on every floor level.
 - Locate an alarm in every bedroom.
 - Locate an alarm in every room where electrical appliances are operated (i.e. portable heaters or humidifiers).
 - Locate an alarm in every room where someone sleeps with the door closed. The closed door may prevent an alarm not located in that room from waking the sleeper.
 - Smoke, heat, and combustion products rise to the ceiling and spread horizontally. Mounting the smoke alarm on the ceiling in the center of the room places it closest to all points in the room. Ceiling mounting is preferred in ordinary residential construction.
 - For mobile home installation, select locations carefully to avoid
- 

thermal barriers that may form at the ceiling. For more details, see MOBILE HOME INSTALLATION below.

- When mounting an alarm on the ceiling, locate it at a minimum of 4" (10cm) from the side wall (see figure 1).
- When mounting the alarm on the wall, use an inside wall with the top edge of the alarm at a minimum of 4" (10cm) and a maximum of 12" (30.5cm) below the ceiling (see figure 1).
- Put smoke alarms at both ends of a bedroom hallway or large room if the hallway or room is more than 30 ft (9.1 m) long.
- Install Smoke Alarms on sloped, peaked or cathedral ceilings at or within 3 ft (0.9m) of the highest point (measured horizontally). NFPA 72 states: "Smoke alarms in rooms with ceiling slopes greater than 1 ft in 8 ft (.3m in 2.4m) horizontally shall be located on the high side of the room." NFPA 72 states: "A row of alarms shall be spaced and located within 3 ft (0.9m) of the peak of the ceiling measured horizontally" (see figure 3).

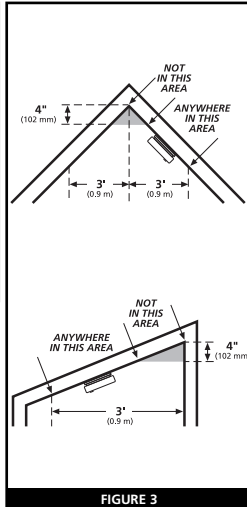
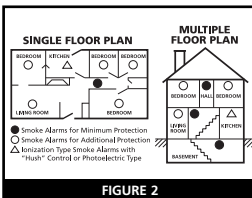
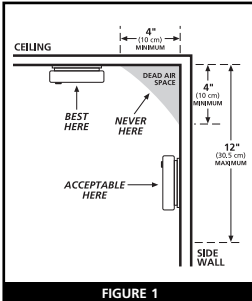

MOBILE HOME INSTALLATION

Modern mobile homes have been designed and built to be energy efficient. Install smoke alarms as recommended above (refer to RECOMMENDED LOCATIONS and figures 1 and 2).

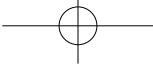

In older mobile homes that are not well insulated compared to present standards, extreme heat or cold can be transferred from the outside to the inside through poorly insulated walls and roof. This may create a thermal barrier which can prevent the smoke from reaching an alarm mounted on the ceiling. In such units, install the smoke alarm on an inside wall with the top edge of the alarm at a minimum of 4" (10cm) and a maximum of 12" (30.5cm) below the ceiling (see figure 1).

If you are not sure about the insulation in your mobile home, or if you notice that the outer walls and ceiling are either hot or cold, install the alarm on an inside wall. For minimum protection, install at least one alarm close to the bedrooms. For additional protection, see SINGLE FLOOR PLAN in figure 2.

WARNING: TEST YOUR SMOKE ALARM OPERATION AFTER RV OR MOBILE HOME VEHICLE HAS BEEN IN STORAGE, BEFORE EACH TRIP AND AT LEAST ONCE A WEEK DURING USE.

2. LOCATIONS TO AVOID

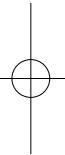
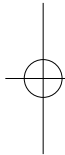
- 
- In the garage. Products of combustion are present when you start your automobile.
 - Less than 4" (10cm) from the peak of an "A" frame type ceiling.
 - In an area where the temperature may fall below 40°F or rise above 100°F, such as garages and unfinished attics.
 - In dusty areas. Dust particles may cause nuisance alarm or failure to alarm.
 - In very humid areas (greater than 85% R.H.). Moisture or steam can cause nuisance alarms.
 - In insect-infested areas.
 - Smoke alarms should not be installed within 3 ft (.9m) of the following: the door to a kitchen, the door to a bathroom containing a tub or shower, forced air supply ducts used for heating or cooling, ceiling or whole house ventilating fans, or other high air flow areas.
 - Kitchens. Normal cooking may cause nuisance alarms. If a kitchen alarm is desired, it should have an alarm silence feature or be a photoelectric type.
 - Near fluorescent lights. Electronic "noise" may cause nuisance alarms.
 - Smoke alarms are not to be used with detector guards unless the
- 

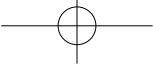

combination (alarm and guard) has been evaluated and found suitable for that purpose.

3. INSTALLATION INSTRUCTIONS

WIRING REQUIREMENTS

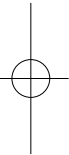
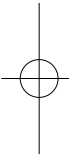
- This smoke alarm should be installed on a U.L. listed or recognized junction box. All connections should be made by a qualified electrician and all wiring used shall be in accordance with articles 210 and 300.3(B) of the U.S. National Electrical Code ANSI/NFPA 70, NFPA 72 and/or any other codes having jurisdiction in your area. The multiple station interconnect wiring to the alarms must be run in the same raceway or cable as the AC power wiring. In addition, the resistance of the interconnect wiring shall be a maximum of 10 ohms.
 - The appropriate power source is 120 Volt AC Single Phase supplied from a non-switchable circuit which is not protected by a ground fault interrupter.
 - **WARNING:** This alarm cannot be operated from power derived from a square wave, modified square wave or modified sine wave inverters. These types of inverters are sometimes used to supply power to the structure in off grid installations, such as solar or wind derived power sources. These power sources produce high peak voltages that will damage the alarm.
- 
- 

WIRING INSTRUCTIONS FOR AC QUICK CONNECT HARNESS

CAUTION! TURN OFF THE MAIN POWER TO THE CIRCUIT BEFORE WIRING THE ALARM.

- For alarms that are used as single station, **DO NOT CONNECT THE RED WIRE TO ANYTHING.** Leave the red wire insulating cap in place to make certain that the red wire cannot contact any metal parts or the electrical box.
- When alarms are interconnected, all interconnected units must be powered from a single circuit.
- A maximum of 24 Kidde devices may be interconnected in a multiple station arrangement. The interconnect system should not exceed the NFPA interconnect limit of 12 smoke alarms and/or 18 alarms total (smoke, heat, carbon monoxide, etc.). With 18 alarms interconnected, it is still possible to interconnect up to a total of 6 remote signaling devices and/or relay modules.

- When mixing models which have battery backup (i12040, i12040A, i12060, i12060A, i12080, i12080A, i12090A, i4618, i1418A, 1275, 1276, 1285, 1296, PE120, P12040, PI2000, PI2010, KN-COSM-IB, RF-SM-ACDC, KN-COPE-I, KN-SMFM-I, HD135F, KN-COB-IC, KN-COP-IC) with models without battery backup, (i1235, i12020, i12020A, KN-COSM-I SM120X, CO120X, SL177I) be advised that the models without battery backup will not respond during an AC power failure.
- The maximum wire run distance between the first and last unit in an interconnected system is 1000 feet.
- Figure 4 illustrates interconnection wiring. Improper connection will result in damage to the alarm, failure to operate, or a shock hazard.
- Make certain alarms are wired to a continuous (non-switched) power line. NOTE: Use standard UL listed household wire (as required by local codes) available at all electrical supply stores and most hardware stores.

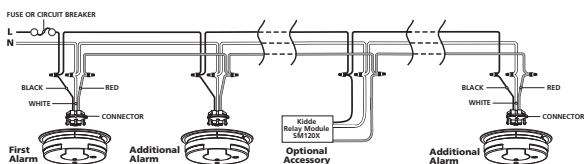

FIGURE 4 INTERCONNECT WIRING DIAGRAM

WIRES ON ALARM HARNESS CONNECTED TO

- | | |
|-------|--|
| Black | Hot Side of AC Line |
| White | Neutral Side of AC Line |
| Red | Interconnect Lines (Red Wires) of Other Units in the Multiple Station Set up |

BATTERY INSTALLATION

See Maintenance (section 6) for battery installation

CAUTION! IF BATTERY REMINDER FINGER IS NOT HELD DOWN IN THE BATTERY COMPARTMENT BY THE BATTERY, THE BATTERY DOOR WILL NOT CLOSE, THE AC QUICK CONNECTOR WILL NOT ATTACH TO THE ALARM, AND THE ALARM WILL NOT ATTACH TO THE TRIM RING (SEE SECTION 6, FIGURE 9).

MOUNTING INSTRUCTIONS

CAUTION: THIS UNIT IS SEALED. THE COVER IS NOT REMOVABLE!

1. Remove the trim ring from the back of the alarm by holding the trim ring and twisting the alarm in the direction indicated by the "OFF" arrow on the alarm cover.
2. After selecting the proper smoke alarm location as described in section 1 and wiring the AC QUICK CONNECT harness as described in the WIRING INSTRUCTIONS, attach the trim ring to the electrical box (see figure 5).
3. Use a screwdriver to punch out only the pair of holes in the trim ring that match your type of electrical box or plaster ring. Mount the trim ring to the electrical box, using the appropriate holes. NOTE: Use the circle, square and octagon markings near each mounting hole in the trim ring to help you select the correct mounting holes (see figure 5).
4. Pull the AC QUICK CONNECTOR through the center hole in the trim ring and mount the ring, making sure that the mounting screws are positioned in the small ends of the keyholes before tightening the screws (see figure 5).
5. Plug the AC QUICK CONNECTOR into the back of the alarm (see figure 6), making sure that the locks on the connector snap into place. Then push the excess wire back into the electrical box through the hole in the center of the trim ring.
6. If you have finished all the WIRING, BATTERY INSTALLATION AND TRIM RING MOUNTING STEPS, you can install the alarm on the trim ring. Alignment marks are provided on the side of the alarm and on the trim ring (see figure 7).
7. Install the alarm on the trim ring with the indicating marks aligned and rotate the alarm in the direction of the "ON" arrow on the cover until the alarm snaps in place (see figure 7).
8. Turn on the AC power. The green AC Power On Indicator should be lit when the alarm is operating from AC power.

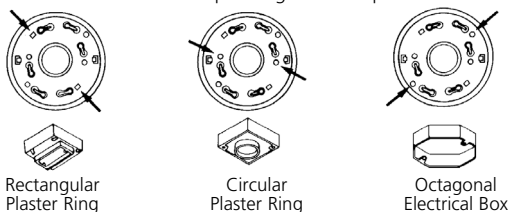

FIGURE 5 SELECT CORRECT MOUNTING HOLES ON TRIM RING

TAMPER RESIST LOCKING PIN: To make your smoke alarm tamper resistant, a locking pin has been provided with your alarm. Using this pin will help deter children and others from removing the alarm from trim ring. To use the pin, insert it into the hole in the side of the alarm after the alarm has been installed on the trim ring (see figure 8). **NOTE:** The tamper resist pin will have to be removed in order to change the batteries. Use long nose pliers to pull the pin out of the hole. It is now possible to remove the alarm from the trim ring.

After installation, **TEST** your alarm by pressing and holding the test button for several seconds. This should sound the alarm.

4. OPERATION AND TESTING

OPERATION: The smoke alarm is operating once a fresh battery is

To remove AC connector, squeeze locking arms and pull.

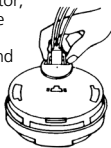

FIGURE 6

Alignment Marks

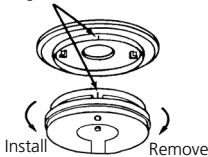

FIGURE 7

Tamper resistant locking pin

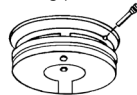
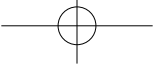

FIGURE 8

installed and testing is complete. When products of combustion are sensed, the unit sounds a loud 85db pulsating alarm until the air is cleared.

HUSH CONTROL: The "HUSH" feature has the capability of temporarily desensitizing the alarm circuit for approximately 10 minutes. This feature is to be used only when a known alarm condition, such as smoke from cooking activates the alarm. The smoke alarm is desensitized by pushing the "HUSH" button on the smoke alarm cover. If the smoke is not too dense, the alarm will silence immediately and the red LED will flash every 10 seconds for approximately 10 minutes. This indicates that the alarm is in a temporarily desensitized condition. The smoke alarm will automatically reset after approximately 10 minutes, and sound the alarm if smoke is still present. The "HUSH" feature can be used repeatedly until the air has been cleared of the condition causing the alarm.

NOTE: DENSE SMOKE WILL OVERRIDE THE HUSH CONTROL FEATURE AND SOUND A CONTINUOUS ALARM.



CAUTION: BEFORE USING THE ALARM HUSH FEATURE, IDENTIFY THE SOURCE OF THE SMOKE AND BE CERTAIN A SAFE CONDITION EXISTS.

LED INDICATORS: This smoke alarm is equipped with red and green LED indicators. The red LED is located under the test button and has two modes of operation.

Standby Condition: The red LED will flash every 30-40 seconds to indicate that the smoke alarm is operating properly.

Alarm Condition: When the alarm senses products of combustion and goes into alarm, the red LED will flash rapidly (one flash per second). The rapid flashing LED and pulsating alarm will continue until the air is cleared.

Hush Condition: The red LED will flash every 10 seconds as long as the alarm is in Hush mode.

SMOKE SENSING CHAMBER OPERATION: This alarm will “chirp” if any of the components in the smoke sensing chamber fail. This chirp will occur between the flashes of the red LED indicator light. (If the chirp occurs at the same time as the red LED flash, see section 6 for low battery information).

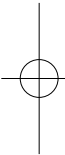
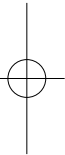

WHEN UNITS ARE INTERCONNECTED, only the red LED of the alarm which senses the smoke or is being tested (the originating unit) will flash rapidly. All other units in the interconnect system will sound an alarm but their red LED's will NOT flash rapidly.

The green LED will be steady on to indicate the presence of AC power.

TESTING: Test by pushing the test button on the cover and holding it down for a minimum of 5 seconds. This will sound the alarm if the electronic circuitry, horn, and battery are working. In an interconnected installation all interconnected alarms should sound when the test button on any one of the interconnected alarm is pressed. If no alarm sounds, check the fuse or circuit breaker supplying power to the alarm circuit. Verify the green LED is on. If the alarm still does not sound, the unit has defective batteries or other failure. **DO NOT** use an open flame to test your alarm, you could damage the alarm or ignite combustible materials and start a structure fire.

TEST THE ALARM WEEKLY TO ENSURE PROPER OPERATION. Erratic or low sound coming from your alarm may indicate a defective alarm, and it should be returned for service (see section 12).

NOTE: WEEKLY TESTING IS REQUIRED.

5. NUISANCE ALARMS

Smoke alarms are designed to minimize nuisance alarms. Cigarette smoke will not normally set off the alarm, unless the smoke is blown directly into the alarm. Combustion particles from cooking may set off the alarm if the alarm is located close to the cooking area. Large quantities of combustible particles are generated from spills or when broiling. Using the fan on a range hood which vents to the outside (non-recirculating type) will also help remove these combustible products from the kitchen.

If the alarm does sound, check for fires first. If a fire is discovered, get out and call the fire department. If no fire is present, check to see if one of the reasons listed in section 2 may have caused the alarm. The Model P12040 has a "HUSH" control that is extremely useful in a kitchen area or other areas prone to nuisance alarms. For more information refer to section 4, OPERATION AND TESTING.

6. MAINTENANCE

IF TAMPER RESIST PIN HAS BEEN USED, REFER TO TAMPER RESIST LOCKING PIN IN SECTION 3 FOR PIN REMOVAL INSTRUCTIONS.

To replace the battery, remove the alarm from the trim ring by rotating the alarm in the direction of the "OFF" arrow on the cover (see Section 3, Figure 7) To disconnect the A.C. power harness, squeeze the locking arms on the sides of the Quick connector while pulling the connector away from the bottom of the alarm (see Section 3, Figure 6).

BATTERY INSTALLATION AND REMOVAL

To replace or install the batteries, you must first remove the alarm from the trim ring by following the ALARM REMOVAL instructions at the beginning of this section. After alarm has been removed, you can open the battery door and install or replace the battery. Battery installation instructions are provided on the inside of the battery door.

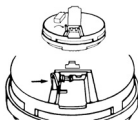
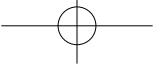

FIGURE 9



When installing the battery, press the battery reminder finger down into the battery compartment and install the battery (see Figure 9).

CAUTION! IF THE BATTERY REMINDER FINGER IS NOT HELD DOWN IN THE BATTERY COMPARTMENT BY THE BATTERY, THE BATTERY DOOR WILL NOT CLOSE, THE A.C. QUICK CONNECTOR WILL NOT ATTACH TO THE ALARM, AND THE ALARM WILL NOT ATTACH TO THE TRIM RING.

The Model P12040 Smoke Alarm uses a 9V backup battery (Carbon zinc, alkaline and lithium batteries may be used). A fresh battery should last for one year under normal operating conditions. This alarm has a low battery monitor circuit which will cause the alarm to “chirp” approximately every 30 - 40 seconds for a minimum of seven (7) days when the battery gets low. Replace the battery when this condition occurs.

USE ONLY THE FOLLOWING 9 VOLT BATTERIES FOR SMOKE ALARM REPLACEMENT.

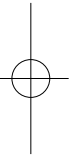

Carbon Zinc Type:	EVEREADY 1222; GOLD PEAK 1604P OR 1604S
Alkaline Type:	ENERGIZER 522; DURACELL MN1604, MX1604,GOLD PEAK 1604A PANASONIC 6AM6, 6AM-6, 6AM-6PI, 6AM6X, and 6LR61(GA)
Lithium Type:	ULTRALIFE U9VL-J

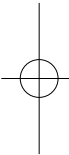

NOTE: WEEKLY TESTING IS REQUIRED.

WARNING!! USE ONLY THE BATTERIES SPECIFIED. USE OF DIFFERENT BATTERIES MAY HAVE A DETRIMENTAL EFFECT ON THE SMOKE ALARM.

CLEANING YOUR ALARM

YOUR ALARM SHOULD BE CLEANED AT LEAST ONCE A YEAR

To clean your alarm, remove it from the mounting bracket as outlined in the beginning of this section. You can clean the interior of your alarm (sensing chamber) by using compressed air or a vacuum cleaner hose and blowing or vacuuming through the openings around the perimeter of the alarm. The outside of the alarm can be wiped with a damp cloth. If cleaning does not restore the alarm to normal operation the alarm should be replaced.

After cleaning, reinstall your alarm. Test your alarm by using the test button and check that the green LED is on.



7. LIMITATIONS OF SMOKE ALARMS

WARNING: PLEASE READ CAREFULLY AND THOROUGHLY

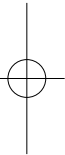
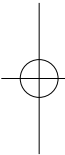
- NFPA 72 states: Life safety from fire in residential occupancies is based primarily on early notification to occupants of the need to escape, followed by the appropriate egress actions by those occupants. Fire warning systems for dwelling units are capable of protecting about half of the occupants in potentially fatal fires. Victims are often intimate with the fire, too old or young, or physically or mentally impaired such that they cannot escape even when warned early enough that escape should be possible. For these people, other strategies such as protection-in-place or assisted escape or rescue are necessary.
 - Smoke alarms are devices that can provide early warning of possible fires at a reasonable cost; however, alarms have sensing limitations. Ionization sensing alarms may detect invisible fire particles (associated with fast flaming fires) sooner than photoelectric alarms. Photoelectric sensing alarms may detect visible fire particles (associated with slow smoldering fires) sooner than ionization alarms. Home fires develop in different ways and are often unpredictable. For maximum protection, Kidde recommends that both Ionization and Photoelectric alarms be installed.
 - A battery powered alarm must have a battery of the specified type, in good condition and installed properly.
 - AC powered alarms (without battery backup) will not operate if the AC power has been cut off, such as by an electrical fire or an open fuse.
 - Smoke alarms must be tested regularly to make sure the batteries and the alarm circuits are in good operating condition.
 - Smoke alarms cannot provide an alarm if smoke does not reach the alarm. Therefore, smoke alarms may not sense fires starting in chimneys, walls, on roofs, on the other side of a closed door or on a different floor.
 - If the alarm is located outside the bedroom or on a different floor, it may not wake up a sound sleeper.
 - The use of alcohol or drugs may also impair one's ability to hear the smoke alarm. For maximum protection, a smoke alarm should be installed in each sleeping area on every level of a home.
 - Although smoke alarms can help save lives by providing an early warning of a fire, they are not a substitute for an insurance policy. Home owners and renters should have adequate insurance to protect their lives and property.
- 
- 

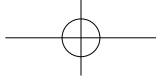

8. GOOD SAFETY HABITS

DEVELOP AND PRACTICE A PLAN OF ESCAPE

- Install and maintain fire extinguishers on every level of the home and in the kitchen, basement and garage. Know how to use a fire extinguisher prior to an emergency.
- Make a floor plan indicating all doors and windows and at least two (2) escape routes from each room. Second story windows may need a rope or chain ladder.
- Have a family meeting and discuss your escape plan, showing everyone what to do in case of fire.
- Determine a place outside your home where you all can meet if a fire occurs.
- Familiarize everyone with the sound of the smoke alarm and train them to leave your home when they hear it.
- Practice a fire drill at least every six months, including fire drills at night. Ensure that small children hear the alarm and wake when it sounds. They must wake up in order to execute the escape plan. Practice allows all occupants to test your plan before an emergency. You may not be able to reach your children. It is important they know what to do.
- Current studies have shown smoke alarms may not awaken all sleeping individuals, and that it is the responsibility of individuals in the household that are capable of assisting others to provide assistance to those who may not be awakened by the alarm sound, or to those who may be incapable of safely evacuating the area unassisted.

WHAT TO DO WHEN THE ALARM SOUNDS

- Alert small children in the home.
- Leave immediately by your escape plan. Every second counts, so don't waste time getting dressed or picking up valuables.
- In leaving, don't open any inside door without first feeling its surface. If hot, or if you see smoke seeping through cracks, don't open that door! Instead, use your alternate exit. If the inside of the door is cool, place your shoulder against it, open it slightly and be ready to slam it shut if heat and smoke rush in.

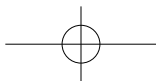
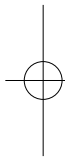
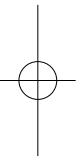

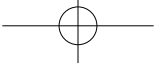
- 
- Stay close to the floor if the air is smoky. Breathe shallowly through a cloth, wet if possible.
 - Once outside, go to your selected meeting place and make sure everyone is there.
 - Call the fire department from your neighbor's home - not from yours!
 - Don't return to your home until the fire officials say that it is all right to do so.

There are situations where a smoke alarm may not be effective to protect against fire as stated in the NFPA Standard 72.

For instance:

- a) smoking in bed
- b) leaving children home alone
- c) cleaning with flammable liquids, such as gasoline



9. NFPA REQUIRED PROTECTION

The National Fire Protection Association's Standard 72 provides the following information:

Smoke Detection - Where required by applicable laws, codes, or standards for the specified occupancy, approved single- and multiple-station smoke alarms shall be installed as follows: (1) In all sleeping rooms Exception: Smoke alarms shall not be required in sleeping rooms in existing one- and two-family dwelling units. (2) Outside of each separate sleeping area, in immediate vicinity of the sleeping rooms. (3) On each level of the dwelling unit, including basements Exception: In existing one- and two-family dwelling units, approved smoke alarms powered by batteries are permitted.

Smoke Detection - Are More Smoke Alarms Desirable? The required number of smoke alarms might not provide reliable early warning protection for those areas separated by a door from the areas protected by the required smoke alarms. For this reason, it is recommended that the householder consider the use of additional smoke alarms for those areas for increased protection. The additional areas include the basement, bedrooms, dining room, furnace room, utility room, and hallways not protected by the required smoke alarms. The installation of the smoke alarms in the kitchen, attic (finished or unfinished), or garage is normally not recommended, as these locations occasionally experience conditions that can result in improper operation.



This equipment should be installed in accordance with the National Fire Protection Association's Standard 72 (NFPA, Batterymarch Park, Quincy, MA 02269).

NOTIFY YOUR LOCAL FIRE DEPARTMENT AND INSURANCE COMPANY OF YOUR SMOKE ALARM INSTALLATION.

10. CAUTION (AS REQUIRED BY THE CALIFORNIA STATE FIRE MARSHAL)

"Early warning fire detection is best achieved by the installation of fire detection equipment in all rooms and areas of the household as follows. A smoke alarm installed in each separate sleeping area (in the vicinity of, but outside of the bedrooms), and heat or smoke alarms in the living rooms, dining rooms, bedrooms, kitchens, hallways, attics, furnace rooms, closets, utility and storage rooms, basements and attached garages".

11. SERVICE AND WARRANTY

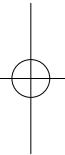

If after reviewing this manual you feel that your smoke alarm is defective in any way, do not tamper with the unit. Return it for servicing to: Kidde, 1016 Corporate Park Dr., Mebane, NC 27302. 1-800-880-6788 (See Warranty for in-warranty returns).

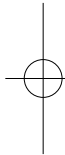

TEN YEAR LIMITED WARRANTY

Kidde warrants to the original purchaser that the enclosed smoke alarm (but not the battery) will be free from defects in material and workmanship or design under normal use and service for a period of ten years from the date of purchase. The obligation of Kidde under this warranty is limited to repairing or replacing the smoke alarm or any part which we find to be defective in material, workmanship or design, free of charge to the customer, upon sending the smoke alarm with proof of date of purchase, postage and return postage prepaid, to Warranty Service Department, Kidde, 1016 Corporate Park Dr., Mebane, NC 27302.

This warranty shall not apply to the smoke alarm if it has been damaged, modified, abused or altered after the date of purchase or if it fails to operate due to improper maintenance or inadequate AC or DC electrical power.

THE LIABILITY OF KIDDE OR ANY OF ITS PARENT OR SUBSIDIARY CORPORATIONS ARISING FROM THE SALE OF THIS SMOKE ALARM OR UNDER THE TERMS OF THIS LIMITED WARRANTY SHALL NOT IN ANY CASE EXCEED THE COST OF REPLACEMENT OF SMOKE ALARM AND, IN NO CASE, SHALL KIDDE OR ANY OF ITS PARENT OR SUBSIDIARY CORPORATIONS BE LIABLE FOR CONSEQUENTIAL LOSS OR DAMAGES RESULTING FROM THE FAILURE OF THE SMOKE ALARM OR FOR BREACH OF THIS OR ANY OTHER WARRANTY, EXPRESS OR IMPLIED, EVEN IF THE LOSS OR DAMAGE IS CAUSED BY THE COMPANY'S NEGLIGENCE OR FAULT.

Since some states do not allow limitations on the duration of an implied warranty or do not allow the exclusion or limitation of incidental or consequential damages, the above limitations or exclusions may not apply to you. While this warranty gives you specific legal rights, you may also have other rights which vary from state to state.

Also, Kidde makes no warranty, express or implied, written or oral, including that of merchantability or fitness for any particular purpose, with respect to the battery.

The above warranty may not be altered except in writing signed by both parties hereto.

QUESTIONS OR FOR MORE INFORMATION

Call our Consumer Hotline at **1-800-880-6788** or contact us at our website at **www.kidde.com**



Kidde, 1016 Corporate Park Drive, Mebane, NC 27302