

# Owner's Manual

## Automatic Standby Generator

# Honeywell

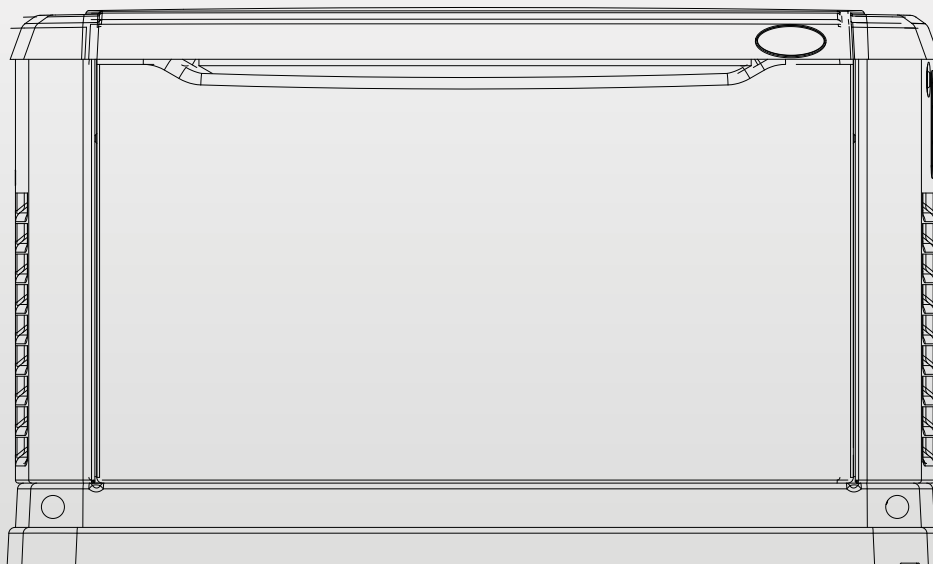

8 kW to 22 kW

### **⚠ DANGER!**

- ⚠ NOT INTENDED FOR USE IN CRITICAL LIFE SUPPORT APPLICATIONS.**
- ⚠ ONLY QUALIFIED ELECTRICIANS OR CONTRACTORS SHOULD ATTEMPT INSTALLATION.**
- ⚠ DEADLY EXHAUST FUMES! OUTDOOR INSTALLATION ONLY!**

To locate in Spanish, go to <http://www.generac.com/service-support/product-support-lookup>

To locate in French, go to <http://www.generac.com/service-support/product-support-lookup>

Reference all appropriate documentation.  
This manual should remain with the unit.



Use this page to record important information about your generator set.

|        |                      |
|--------|----------------------|
| MODEL  | <input type="text"/> |
| SERIAL | <input type="text"/> |
| VOLTS  | <input type="text"/> |
| AMPS   | <input type="text"/> |

1 PH, 60 Hz, RPM 3600  
RAINPROOF ENCLOSURE FITTED  
CLASS H INSULATION  
RATED AMBIENT TEMP – 25°C

---

FOR STANDBY SERVICE

---

**NEUTRAL FLOATING**  
MAX LOAD UNBALANCE–50%

WHITEWATER, WIS  
MADE IN U.S.A.

Record the information found on your unit data label on this page. For the location of the unit data label, see Section 2 General Information. The unit has a label plate affixed to the inside partition, to the left of the control panel console as shown in Figures 2-1, 2-2, and 2-3. For directions on how to open the top lid and remove the front panel, see Section 3 Operation. The Unit Identification label provides the following information:

- Model Number
- Serial Number
- Control Panel Part Number
- Voltage Rating of the unit
- Maximum Current Rating of the unit (AMPS)

When contacting an independent Authorized Service Dealer about parts and service, always supply the complete model number and serial number of the unit.

**Operation and Maintenance:** Proper maintenance and care of the generator ensures a minimum number of problems and keeps operating expenses at a minimum. It is the operator's responsibility to perform all safety checks, to make sure that all maintenance for safe operation is performed promptly, and to have the equipment checked periodically by an independent Authorized Service Dealer. Normal maintenance, service and replacement of parts are the responsibility of the owner/operator and, as such, are not considered defects in materials or workmanship within the terms of the warranty. Individual operating habits and usage may contribute to the need for additional maintenance or service.

When the generator requires servicing or repairs, contact an independent Authorized Service Dealer for assistance. Authorized service technicians are factory-trained and are capable of handling all service needs.

To find your Local Independent AUTHORIZED SERVICE DEALER

## INDEPENDENT AUTHORIZED SERVICE DEALER LOCATION

To locate the nearest INDEPENDENT AUTHORIZED SERVICE DEALER, please call this number:

**1-800-333-1322**

or, visit the dealer locator at:

**[www.generac.com/Service/Dealer Locator](http://www.generac.com/Service/Dealer Locator)**

## WARNING!

### California Proposition 65

Engine exhaust and some of its constituents are known to the state of California to cause cancer, birth defects, and other reproductive harm.

## WARNING!

### California Proposition 65

This product contains or emits chemicals known to the state of California to cause cancer, birth defects, and other reproductive harm.

---

# *Table of Contents*

---

|   |    |
|---|----|
| Section 1 — Safety . . . . .  | 1  |
| 1.1 — General Safety . . . . .                                      | 2  |
| 1.2 — General Safety Hazards . . . . .                              | 2  |
| 1.3 — Exhaust Hazards . . . . .                                     | 3  |
| 1.4 — Electrical Hazards . . . . .                                  | 3  |
| 1.5 — Fire Hazards . . . . .  | 3  |
| 1.6 — Explosion Hazards . . . . .                                   | 3  |
| Section 2 — General Information . . . . .                           | 5  |
| 2.1 — The Generator . . . . .                                       | 5  |
| 2.2 — Protection Systems . . . . .                                  | 6  |
| 2.3 — Emission Information . . . . .                                | 7  |
| 2.4 — Specifications . . . . .                                      | 8  |
| 2.5 — Accessories . . . . .   | 9  |
| Section 3 — Operation . . . . .                                     | 11 |
| 3.1 — Control Panel Interface . . . . .                             | 11 |
| 3.2 — Using the Auto/Off/Manual Buttons . . . . .                   | 12 |
| 3.3 — Interface Menu Displays . . . . .                             | 12 |
| 3.4 — Automatic Transfer Operation . . . . .                        | 14 |
| 3.5 — Turning the Generator Off When Operating Under Load . . . . . | 15 |
| 3.6 — Manual Transfer Operation . . . . .                           | 15 |
| 3.7 — Side Compartment . . . . .                                    | 17 |
| 3.8 — Battery Charger . . . . .                                     | 17 |
| 3.9 — Setting the Exercise Timer . . . . .                          | 18 |
| Section 4 — Maintenance . . . . .                                   | 21 |
| 4.1 — Performing Scheduled Maintenance . . . . .                    | 21 |
| 4.2 — Service Schedule . . . . .                                    | 21 |
| 4.3 — Checking Engine Oil Level . . . . .                           | 22 |
| 4.4 — Changing the Engine Air Cleaner . . . . .                     | 24 |
| 4.5 — Spark Plugs . . . . .   | 24 |
| 4.6 — Valve Lash Adjustment . . . . .                               | 25 |
| 4.7 — Battery Maintenance . . . . .                                 | 26 |
| 4.8 — Attention After Submersion . . . . .                          | 27 |
| 4.9 — Corrosion Protection . . . . .                                | 27 |
| 4.10 — Out of Service Procedure . . . . .                           | 27 |
| Section 5 — Troubleshooting . . . . .                               | 29 |
| Section 6 — Quick Reference Guide . . . . .                         | 31 |

---

**This page intentionally left blank.**

---

## Section 1

# Safety

---

**INTRODUCTION:** Thank you for purchasing this compact, high performance, air-cooled, engine-driven stationary automatic standby generator set. Every effort was made to make sure that the information and instructions in this manual were both accurate and current at the time the manual was written. However, the manufacturer reserves the right to change, alter or otherwise improve this product or manual at any time without prior notice.

This generator is designed to automatically supply electrical power to operate critical loads during a utility power failure. This unit is factory installed in an all-weather metal enclosure and is **intended exclusively for outdoor installation**. This generator will operate using either vapor withdrawn liquid propane (LP) or natural gas (NG).

**NOTE:** When properly sized, this generator is suitable for supplying typical residential loads such as Induction Motors (sump pumps, refrigerators, air conditioners, furnaces, etc.), Electronic Components (computer, monitor, TV, etc.), Lighting Loads and Microwaves.

**READ THIS MANUAL THOROUGHLY:** The operator is responsible for proper and safe use of this equipment. The manufacturer strongly recommends that the operator read and thoroughly understand the instructions and contents of this owner's manual before attempting to use the equipment. If any portion of this publication is not understood, contact the nearest Authorized Service Dealer for starting, operating and servicing procedures.

**SAVE THESE INSTRUCTIONS:** The manufacturer suggests that this manual and the rules for safe operation be copied and posted near the unit's installation site. Safety should be stressed to all operators and potential operators of this equipment.

**SAFETY:** Throughout this manual, and on tags and decals affixed to the unit, DANGER, WARNING, CAUTION and NOTE blocks are used to alert personnel to special instructions about a particular operation, function or service that may be hazardous if performed incorrectly or carelessly. Observe them carefully. Their definitions are as follows:

### **⚠ DANGER!**

INDICATES A HAZARDOUS SITUATION OR ACTION WHICH, IF NOT AVOIDED, WILL RESULT IN DEATH OR SERIOUS INJURY.

### **⚠ WARNING!**

Indicates a hazardous situation or action which, if not avoided, could result in death or serious injury.

### **⚠ CAUTION!**

Indicates a hazardous situation which, if not avoided, could result in minor or moderate injury.

**NOTE:** Notes contain additional information important to an operation or procedure.

Four commonly used safety symbols accompany the DANGER, WARNING and CAUTION blocks. The type of information each indicates is as follows:



This symbol points out important Safety Information that, if not followed, could endanger personal safety and/or property of others.



This symbol points out a potential Explosion Hazard.



This symbol points out a potential Fire Hazard.



This symbol points out a potential Electrical Shock Hazard.

These "Safety Alerts" cannot eliminate the hazards that they signal. Strict compliance with these special instructions, plus common sense are major accident prevention measures.





---

## 1.1 — General Safety

Study these safety rules carefully before operating or servicing this equipment. Become familiar with this Owner's Manual and with the unit. The generator can operate safely, efficiently and reliably only if it is properly installed, operated and maintained. Many accidents are caused by failing to follow simple and fundamental rules or precautions.

The manufacturer cannot anticipate every possible circumstance that might involve a hazard. The warnings in this manual, and on tags and decals affixed to the unit are, therefore, not all-inclusive. If using a procedure, work method or operating technique the manufacturer does not specifically recommend, ensure that it is safe for personnel. Also make sure the procedure, work method or operating technique utilized does not render the generator unsafe.

### **⚠ DANGER!**

-  Despite the safe design of this generator, operating this equipment imprudently, neglecting its maintenance or being careless can cause possible injury or death. Permit only responsible and capable persons to install, operate and maintain this equipment.
-  Potentially lethal voltages are generated by these machines. Ensure steps are taken to make the machine safe before attempting to work on the generator.
-  Parts of the generator are rotating and/or hot during operation. Exercise care near a running generator.
-  The installation of this generator must always comply with applicable codes, standards, laws and regulations.
-  A running generator gives off DEADLY carbon monoxide, an odorless, colorless, poisonous gas. Breathing carbon monoxide can cause dizziness, throbbing temples, nausea, muscular twitching, headache, vomiting, weakness, sleepiness, inability to think clearly, fainting, unconsciousness or even death.

### **⚠ CAUTION!**

-  The control panel for this unit is intended to be operated by qualified service personnel only.

## 1.2 — General Safety Hazards

- For safety reasons, this equipment should only be installed, serviced and repaired by a Service Dealer or other competent, qualified electrician or installation technician who is familiar with applicable codes, standards, regulations and product Installation Manual guidelines. The operator also must comply with all such codes, standards, regulations and product Installation Manual guidelines.
- The engine exhaust fumes contain carbon monoxide, which can be DEADLY. This dangerous gas, if breathed in sufficient concentrations, can cause unconsciousness or even death. DO NOT alter or add to the exhaust system or do anything that might render the system unsafe or in noncompliance with applicable codes and standards.
- Install a carbon monoxide alarm indoors, according to manufacturer's instructions/recommendations.
- Adequate, unobstructed flow of cooling and ventilating air is critical for correct generator operation. Do not alter the installation or permit even partial blockage of ventilation provisions, as this can seriously affect safe operation of the generator. The generator MUST be installed and operated outdoors only.
- Keep hands, feet, clothing, etc. away from drive belts, fans, and other moving or hot parts. Never remove any drive belt or fan guard while the unit is operating.
- When working on this equipment, remain alert at all times. Never work on the equipment when physically or mentally fatigued.
- Inspect the generator regularly, and contact the nearest Dealer for parts needing repair or replacement.
- Before performing any maintenance on the generator, remove the control panel fuse and disconnect the Negative (—) battery cable to prevent accidental startup. When disconnecting battery cables always remove the NEGATIVE (NEG or "—") cable first, then remove the POSITIVE (POS, or "+") cable. When reconnecting the cables, connect the POSITIVE cable first, and the NEGATIVE cable last.
- Never use the generator or any of its parts as a step. Stepping on the unit can stress and break parts, and may result in dangerous operating conditions from leaking exhaust gases, fuel leakage, oil leakage, etc.

---

## 1.3 — Exhaust Hazards

- Generator engine exhaust contains DEADLY carbon monoxide, an odorless, colorless, poisonous gas. Breathing carbon monoxide can cause dizziness, throbbing temples, nausea, muscular twitching, headache, vomiting, weakness, sleepiness, inability to think clearly, fainting, unconsciousness or even death. If any carbon monoxide poisoning symptom is experienced, move into fresh air and immediately seek medical attention.
- This generator is designed for OUTDOOR installation ONLY. Never operate the generator inside any garage or other enclosed space.

## 1.4 — Electrical Hazards

- All generators covered by this manual produce dangerous electrical voltages that can cause fatal electrical shock. Utility power delivers extremely high and dangerous voltages to the transfer switch, as does the standby generator when it is in operation. Avoid contact with bare wires, terminals, connections, etc. while the unit is running. Ensure all appropriate covers, guards and barriers are in place, secured and/or locked before operating the generator. If work must be done around an operating unit, stand on an insulated, dry surface to reduce potential shock hazard.
- Do not handle any kind of electrical device while standing in water, while barefoot, or while hands or feet are wet. DANGEROUS ELECTRICAL SHOCK MAY RESULT.
- This is an Automatic Standby Generator, the generator may crank and start at any time when utility is lost. When this occurs, load circuits are transferred to the STANDBY (generator) power source. To prevent injury, before working on this generator (for inspection, service or maintenance), always put the generator into the OFF mode and remove the 7.5 Amp fuse from the generator control panel.
- In case of accident caused by electric shock, immediately shut down the source of electrical power. If this is not possible, attempt to free the victim from the live conductor. AVOID DIRECT CONTACT WITH THE VICTIM. Use a nonconducting implement, such as a dry rope or board, to free the victim from the live conductor. If the victim is unconscious, apply first aid and get immediate medical help.
- Never wear jewelry when working on this equipment. Jewelry can conduct electricity resulting in electric shock, or may get caught in moving components resulting in injury.

## 1.5 — Fire Hazards

- For fire safety, the generator must be installed and maintained properly. Installation MUST always comply with applicable codes, standards, laws, regulations and product Installation Manual guidelines. Adhere strictly to local, state, and national electrical and building codes. Comply with regulations the Occupational Safety and Health Administration (OSHA) has established. Also, ensure that the generator is installed in accordance with the manufacturer's instructions and recommendations. Following proper installation, do nothing that might alter a safe installation and render the unit in noncompliance with the aforementioned codes, standards, laws and regulations.
- Keep a fire extinguisher near the generator at all times. Extinguishers rated "ABC" by the National Fire Protection Association are appropriate for use on the standby generator. Keep the extinguisher properly charged and be familiar with its use. Consult the local fire department with any questions pertaining to fire extinguishers.

## 1.6 — Explosion Hazards

- Do not smoke around the generator. Wipe up any fuel or oil spills immediately. Ensure that no combustible materials are left in the generator compartment, or on or near the generator as FIRE or EXPLOSION may result. Keep the area surrounding the generator clean and free from debris.
- Gaseous fluids such as natural gas and liquid propane (LP) gas are extremely EXPLOSIVE. Install the fuel supply system according to applicable fuel-gas codes. Before placing the home standby electric system into service, fuel system lines must be properly purged and leak tested according to applicable code. After installation, inspect the fuel system periodically for leaks. No leakage can be permitted.

---

**⚠ WARNING!**



If this generator is used to power electrical load circuits normally powered by a utility power source, it is required by code to install a transfer switch. The transfer switch must effectively isolate the electrical system from the utility distribution system when the generator is operating (NEC 702). Failure to isolate an electrical system by such means will result in damage to the generator and also may result in injury or death to utility power workers due to backfeed of electrical energy.



## 2.1 — The Generator

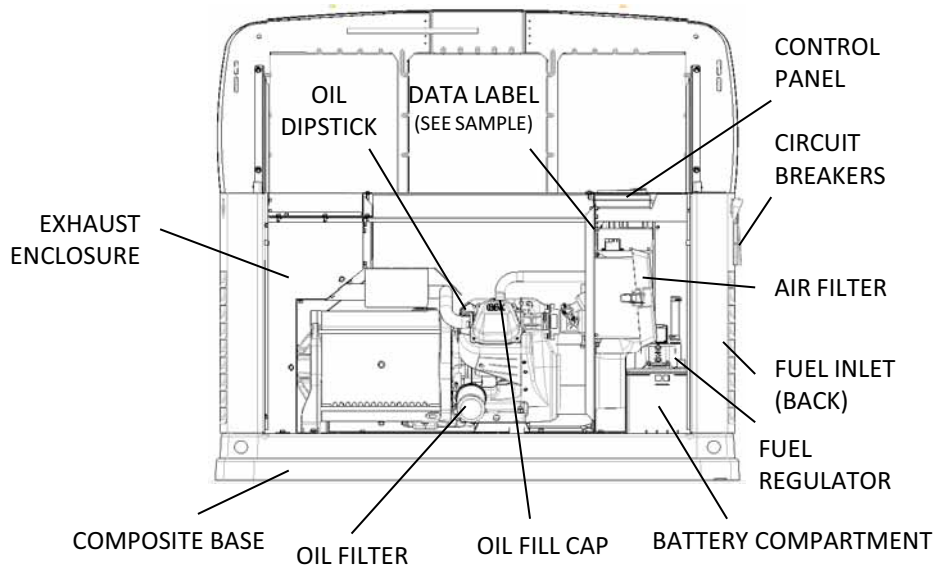

**Figure 2-1: GH-410 Engine 8 kW Unit**

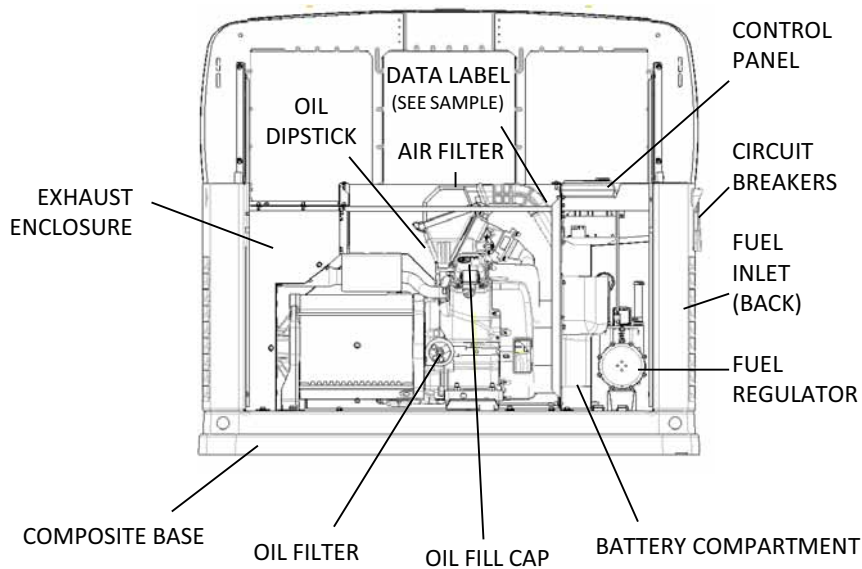

**Figure 2-2: GH-530 Engine 11 kW Unit**

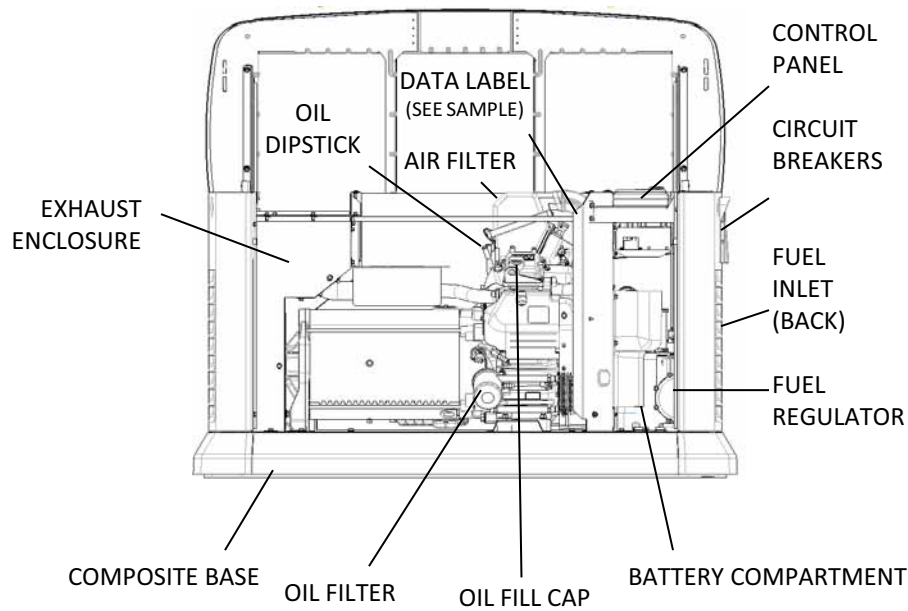

**Figure 2-3: GT-990/GT-999 Engines, 16-22 kW Units**

## 2.2 — Protection Systems

The generator may have to run for long periods of time with no operator present to monitor the engine/generator conditions. Therefore, the generator is equipped with a number of systems to automatically shut down the unit to protect it against potentially damaging conditions. Some of these systems are as follows

Alarms:

- High Temperature
- Low Oil Pressure
- Overcrank
- Overspeed
- Underspeed
- RPM Sensor Loss
- Controller Fault
- Wiring Error

Warnings:

- Charger Warning
- Charger Missing AC
- Low Battery
- Exercise Set Error
- USB Warning
- Download Failure
- Overvoltage
- Undervoltage
- Fuse Problem
- Overload
- Stepper Overcurrent

The control panel contains a display which alerts the operator when a fault condition occurs. The above list is not all inclusive. For more information about alarms and control panel operation, see Section 3 Operation.

**NOTE: A warning will indicate a condition, on the generator, that should be addressed but not shut the generator down. An alarm will shut the generator down to protect the system from any damage. In the event of an alarm, an owner can clear the alarm and restart the generator prior to contacting their independent servicing dealer. If the intermittent issue occurs again, contact your independent servicing dealer.**

---

## 2.3 — Emission Information

The U.S. Environmental Protection Agency (EPA) requires that this generator comply with exhaust emission standards. This generator is certified to meet the applicable EPA emission levels, and is certified for use as a stationary engine for standby power generation. Any other use may be a violation of federal and/or local laws. To ensure that the engine complies with the applicable emission standards for the duration of the engine's life, it is important to follow the maintenance specifications in the Section 4 Maintenance. This generator is certified to operate on Liquid Propane Vapor fuel or pipeline Natural Gas.

For generators 16 kW and greater, the Emission Control System code is EM (Engine Modification). The Emission Control System on this generator consists of the following components:

- Air Induction System
  - Intake Pipe / Manifold
  - Air Cleaner
- Fuel Metering System
  - Carburetor / Mixer Assembly
  - Fuel Regulator
- Ignition System
  - Spark Plug
  - Ignition Module
- Exhaust System
  - Exhaust Manifold
  - Muffler

## 2.4 — Specifications

### 2.4.1 — Generator

| Model   | 8 kW   | 11 kW     | 16 kW     | 20 kW                 | 22 kW    |
|---|--|-----------|-----------|-----------------------|----------|
| Rated Voltage   | 240  |           |           |                       |          |
| Rated Maximum Load Current (Amps) at 240 Volts (LP)*  | 33.3   | 45.8      | 66.6      | 83.3                  | 91.7     |
| Main Circuit Breaker  | 35 Amp   | 50 Amp    | 65 Amp    | 90 Amp                | 100 Amp  |
| Phase   | 1  |           |           |                       |          |
| Rated AC Frequency  | 60 Hz  |           |           |                       |          |
| Battery Requirement   | Group 26R, 12 Volts and 525 CCA Minimum (Generac Part No. 0H3421S)   |           |           |                       |          |
| Weight (unit only in lbs./kilos)  | 360/163.3  | 407/184.6 | 471/213.6 | 451/204.6 - 451/204.6 | 476/216  |
| Enclosure   | Aluminum   | Aluminum  | Aluminum  | Aluminum - Steel      | Aluminum |
| Normal Operating Range  | This unit is tested in accordance to UL 2200 standards with an operating temperature of -20 °F (-29 °C) to 122 °F (50 °C). For areas where temperatures fall below 32 °F (0 °C) a cold weather kit is required. When operated above 77 °F (25 °C) there may be a decrease in engine power. Please reference the engine specifications section. |           |           |                       |          |
| These generators are rated in accordance with UL 2200, Safety Standard for Stationary Engine Generator Assemblies, and CSA-C22.2 No. 100-04 Standard for Motors and Generators. |  |           |           |                       |          |
| * Natural Gas ratings will depend on specific fuel Btu/joules content. Typical derates are between 10-20% off the LP gas rating.  |  |           |           |                       |          |
| ** Circuits to be moved must be protected by same size breaker. For example, a 15 Amp circuit in the main panel must be a 15 Amp circuit in the transfer switch.                |  |           |           |                       |          |

### 2.4.2 — Engine

| Model   | 8 kW                        | 11 kW                | 16 kW                | 20 kW                | 22 kW                |
|---|-----------------------------|----------------------|----------------------|----------------------|----------------------|
| Type of Engine  | GH-410                      | GT-530               | GT-990               | GT-999               | GT-999               |
| Number of Cylinders   | 1                           | 2                    | 2                    | 2                    | 2                    |
| Displacement  | 410 cc                      | 530 cc               | 992 cc               | 999 cc               | 999 cc               |
| Cylinder Block  | Aluminum w/Cast Iron Sleeve |                      |                      |                      |                      |
| Recommended Spark Plug  | RC14YC                      | BPR6HS               | RC14YC               | RC12YC               | RC12YC               |
| Spark Plug Gap  | 0.76 mm (0.030 in)          | 0.76 mm (0.030 in)   | 1.02 mm (0.040 in)   | 0.76 mm (0.030 in)   | 0.76 mm (0.030 in)   |
| Starter   | 12 VDC                      |                      |                      |                      |                      |
| Oil Capacity Including Filter   | Approx. 1.5 Qt/1.4 L        | Approx. 1.7 Qt/1.6 L | Approx. 1.9 Qt/1.8 L | Approx. 1.9 Qt/1.8 L | Approx. 1.9 Qt/1.8 L |
| Recommended Oil Filter  | Part #070185E               |                      |                      |                      |                      |
| Recommended Air Filter  | Part #0E9371A               | Part #0E9371A        | Part #0J8478         | Part #0J8478         | Part #0J8478         |
| Engine power is subject to and limited by such factors as fuel Btu/joules content, ambient temperature and altitude. Engine power decreases about 3.5 percent for each 1,000 feet (304.8 meters) above sea level, and also will decrease about 1 percent for each 6 °C (10 °F) above 15 °C (60 °F) ambient temperature. |                             |                      |                      |                      |                      |

The specification sheet for your generator was included in the documentation provided with the unit at the time of purchase. For additional copies, consult your local Authorized Service Dealer for your specific generator model.

---

### 2.4.3 — Fuel Requirements

The engine has been fitted with a dual fuel carburetion system. The unit will run on natural gas or LP gas (vapor), but it has been factory set to run on natural gas. The fuel system will be configured for the available fuel source during installation.

Recommended fuels should have a btu content of at least 1,000 Btus per cubic foot (37.26 megajoules per cubic meter) for natural gas, or at least 2,500 Btus per cubic foot (93.15 megajoules per cubic meter) for LP gas (vapor).

If converting to LP gas from natural gas, a minimum LP tank size of 250 gallons (946 liters) is recommended. See the Installation Manual for complete procedures and details.

### **⚠ DANGER!**



**Gaseous fuels such as natural gas and liquid propane gas are highly explosive. Even the slightest spark can ignite such fuels and cause an explosion. No leakage of fuel is permitted. Natural gas, which is lighter than air, tends to collect in high areas. LP gas is heavier than air and tends to settle in low areas**

### 2.4.4 — Battery Requirements

Group 26R, 12V, minimum 525CCA (Generac Part No. 0H3421S).

For proper battery maintenance procedures, see Section 4 Maintenance.

### 2.4.5 — Battery Charger

The battery charger is integrated into the control panel module in all models. It operates as a “Smart Charger” which ensures output charging levels are safe and continuously optimized to promote maximum battery life.

### 2.4.6 — Engine Oil Requirements

For proper oil viscosity, see chart in Figure 4-1: Recommended Oil Based on Temperature.

## 2.5 — Accessories

There are performance enhancing accessories available for air-cooled generators.

| Accessory   | Description  |
|---|--|
| Cold Weather Kit  | Required in areas where temperatures regularly fall below 32 °F (0 °C).  |
| Scheduled Maintenance Kit   | Includes all pieces necessary to perform maintenance on the generator along with oil recommendations.  |
| Auxiliary Transfer Switch Lock-out  | Enables any of the transfer switches to completely lock out one large electrical load by tying into its control system.  |
| Touch-Up Paint Kit  | Very important to maintain the look and integrity of the generator enclosure. This kit includes touch-up paint and instructions.   |
| Wireless Local Monitor  | Completely wireless and battery powered, the Wireless Local Monitor provides you with instant status without ever leaving the house. Status lights (red, yellow and green) alert owners when the generator needs attention. Magnetic backing permits refrigerator mounting and gives a 600 foot line of sight communication. |
| Contact an Independent Authorized Dealer for additional information on accessories. |  |

---

**This page intentionally left blank.**

---

## Section 3

# Operation

---

### 3.1 — Control Panel Interface

**⚠ WARNING!**



The control panel on this unit is intended to only be operated by qualified service personnel.

The Control panel interface is located under the lid of the enclosure. Before attempting to lift the lid of the enclosure, verify that both left and right side locks are unlocked. To remove the front cover, lift the cover straight up to disengage the side hooks, then tilt and lift it away from the unit.

When closing the unit, ensure that both left and right side locks are securely locked. See Figure 3-1.

**⚠ WARNING!**



The enclosed keys provided with this unit are for service personnel usage only.

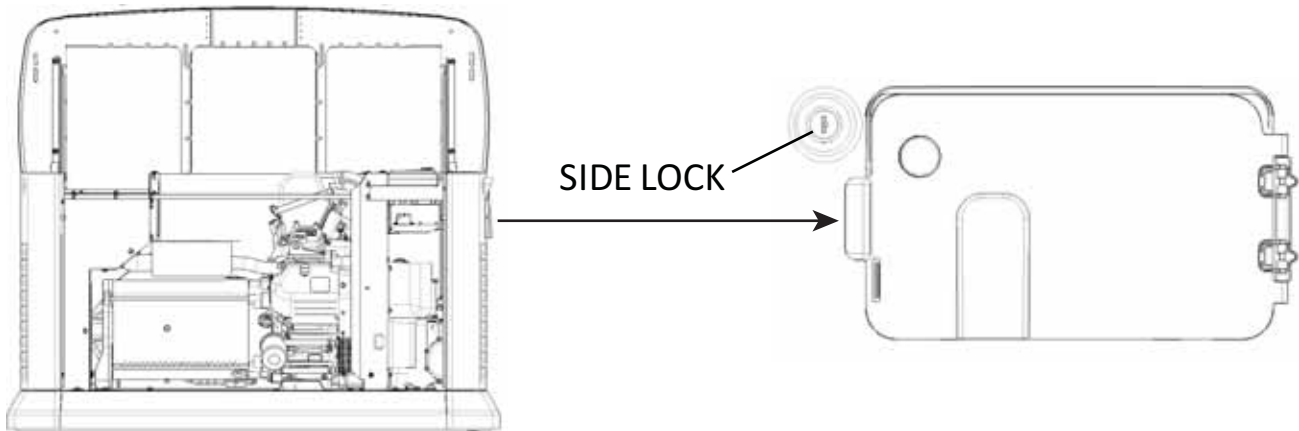

**Figure 3-1: Generator With Lid Open/Side Lock Location**

**⚠ WARNING!**



Set to AUTO, the engine may crank and start at any time without warning. Such automatic starting occurs when utility power source voltage drops below a preset level or during the normal exercise cycle. To prevent possible injury that might be caused by such sudden starts, always set to OFF and remove the fuses before working on or around the generator or transfer switch. Then, place a “DO NOT OPERATE” tag on the generator panel and on the transfer switch.

NOTE: The generator is to be run with all appropriate panels in place, including during troubleshooting by a technician.

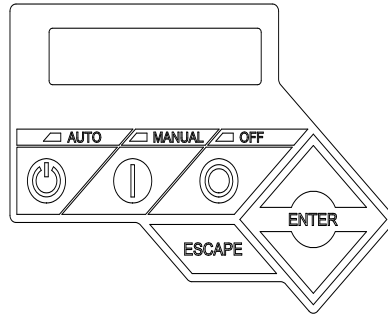

**Figure 3-2: Generator Control Panel**

## 3.2 — Using the Auto/Off/Manual Buttons

| Button | Description of Operation  |
|--------|---|
| Auto   | Selecting this button activates fully automatic system operation. Automatic operation allows the unit to automatically start and exercise the generator according to the exercise timer (see the Setting the Exercise Timer section). |
| Off    | This button shuts down the generator and also prevents automatic operation and exercise of the unit.  |
| Manual | This button will crank and start the generator. Transfer to standby power will not occur unless there is a utility failure.   |

**NOTE:** Damage caused by mis-wiring of the interconnect wires is not warrantable.

## 3.3 — Interface Menu Displays

The LCD display:

| Feature           | Description  |
|-------------------|--|
| HOME page         | The default page which will be displayed if no buttons are pressed for 60 seconds. This page normally shows the current Status message and the current date and time. The highest priority active Alarm/Warning will be automatically posted on this page as well as flashing the backlight when such a condition is detected. In the case of multiple Alarms/Warnings, only the first message will be displayed. To clear an Alarm or Warning, press the OFF button and then press the ENTER key. |
| Display Backlight | Normally off. If the operator presses any button, the backlight will automatically light and remain on for 30 seconds.   |
| MAIN MENU page    | Allows the operator to navigate to all other pages or sub-menus by using the Arrows and Enter buttons. This page can be accessed at any time with several presses of the dedicated Escape button. Each press of the Escape button takes the operator to the previous menu until the MAIN MENU displays. This page contains information for - History; Status; Edit; Debug.   |

### 3.3.1— Menu System Navigation

To get to the MENU, use the “Escape” button from any page. It may require pressing it many times before getting to the MENU page. Navigate to the desired menu by using the ↑/↓ buttons. When the desired menu is displayed and flashing, press the “Enter” button. See Figure 3-3.



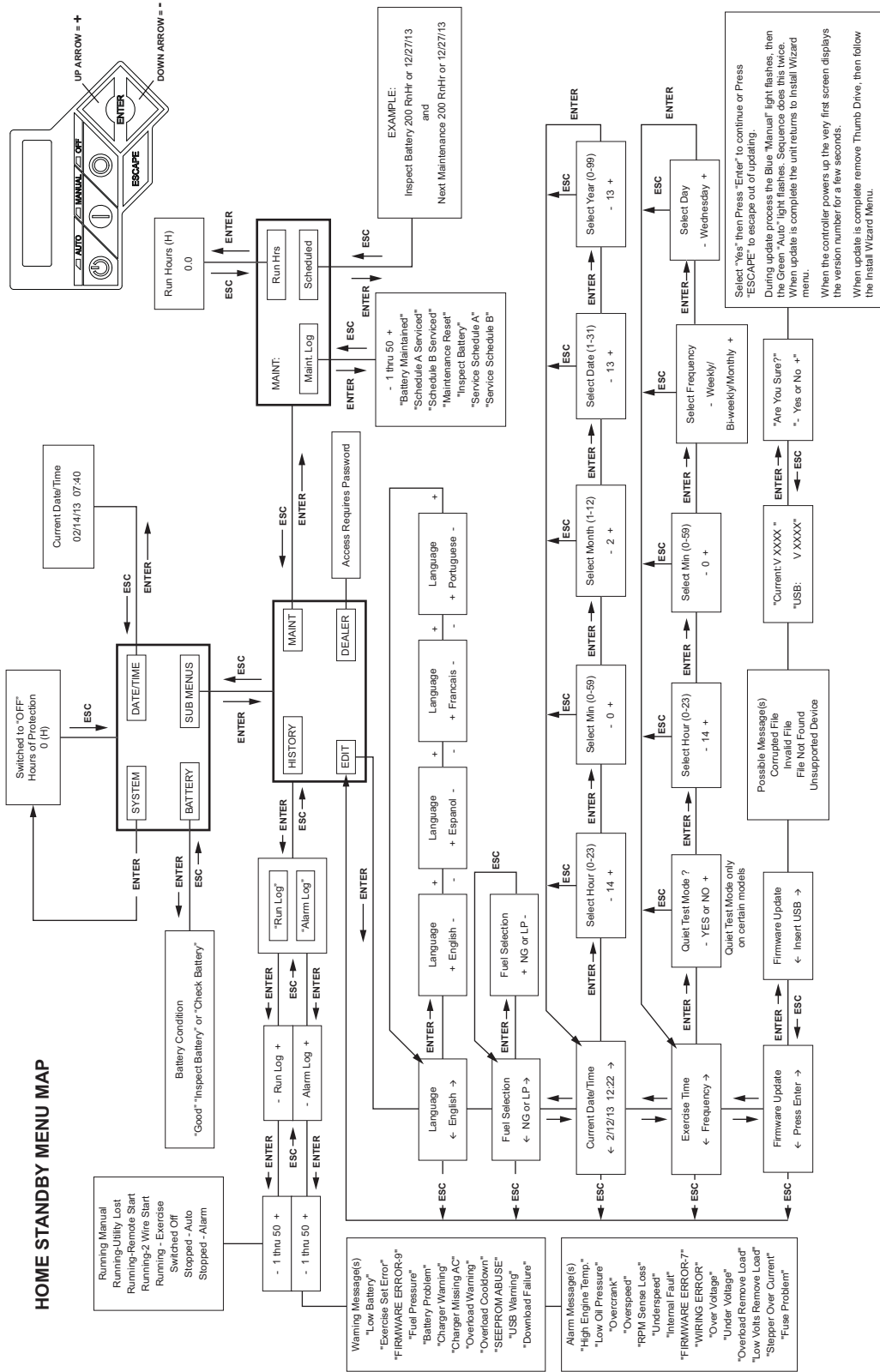

**Figure 3-3: Navigation Menu**

---

## 3.4 — Automatic Transfer Operation

To select automatic operation:

1. Make sure the transfer switch main contacts are set to their UTILITY position (loads connected to the utility power source).
2. Be sure that normal UTILITY power source voltage is available to transfer switch terminal lugs N1 and N2.
3. Press the AUTO button on the Control Panel Interface.
4. Set the Main Circuit Breaker (Generator Disconnect) to its ON (Closed) position.

With these steps complete, the generator will start automatically when utility source voltage drops below a preset level. After the unit starts, loads are transferred to the standby power source.

### 3.4.1— Automatic Sequence of Operation

#### 3.4.1.1 — Utility Failure

With the generator set to AUTO, when the utility fails (below 65% of nominal) a 10 second (optionally programmable) line interrupt delay time is started. If the utility is still gone when the timer expires, the engine will crank and start. Once started, a 5 second engine warm-up timer will be initiated. When the warm-up time expires, the controller will transfer the load to the generator. If the utility power is restored (above 75% nominal) at any time from the initiation of the engine start until the generator is ready to accept load (5 second warm-up time has not elapsed), the controller will complete the start cycle and run the generator through its normal cool down cycle, however, the load will remain on the utility source.

#### 3.4.1.2 — Cranking

The system will control the cyclic cranking as follows:

- 8 kW unit - 5 cranking cycles as follows: 15 second crank, seven (7) second rest, followed by four (4) additional cycles of seven (7) second cranks followed by seven (7) second rests.
- 11 - 22 kW units - 5 cranking cycles as follows: 16 second crank, seven (7) second rest, 16 second crank, seven (7) second rest, followed by three (3) additional cycles of seven (7) second cranks followed by seven (7) second rests.

#### 3.4.1.3 — Load Transfer

The transfer of load when the generator is running is dependent upon the operating mode:

|          |   |
|----------|---|
| MANUAL   | <ul style="list-style-type: none"><li>• Will not transfer to generator if utility is present.</li><li>• Will transfer to generator if utility fails (below 65% of nominal for 10 consecutive seconds).</li><li>• Will transfer back when utility returns for 15 consecutive seconds. The engine will continue to run until removed from the MANUAL mode.</li></ul>  |
| AUTO     | <ul style="list-style-type: none"><li>• Will start and run if utility fails for 10 consecutive seconds (factory default).</li><li>• Will start a 5 second engine warm-up timer.<ul style="list-style-type: none"><li>•Will not transfer if utility subsequently returns.</li><li>•Will transfer to generator if utility is not present.</li></ul></li><li>• Will transfer back to utility once utility returns (above 75% of nominal) for 15 seconds.</li><li>• Will not transfer back to utility unless utility returns. The generator will shut down if the OFF button is pressed or a shutdown alarm is present.</li><li>• Once utility power is returned, the generator will shut down after 1 minute cool-down time.</li></ul> |
| EXERCISE | <ul style="list-style-type: none"><li>• Will not exercise if generator is already running in either AUTO or MANUAL mode.</li><li>• During exercise, the controller will only transfer if utility fails during exercise for 10 seconds, and will switch to AUTO.</li></ul>   |

## 3.5 — Turning the Generator Off When Operating Under Load

**NOTE: Important!** To turn the generator off during prolonged utility outages to perform maintenance or conserve fuel, follow these simple, but important steps:

To turn the generator OFF (while running in AUTO and online):

1. Turn OFF (or OPEN) the main Utility disconnect.
2. Turn OFF (or OPEN) the Main Line Circuit Breaker (MLCB) on the generator. and allow the generator to run for 1 minute to cool down.
3. Turn the generator OFF. If the generator is to remain off for more than an hour, remove the 7.5 Amp fuse from the control panel to avoid running down the starting battery, if utility is not present.

To turn the generator back ON:

1. Put the generator back into AUTO and allow to start and warm-up for a few minutes.
2. Turn ON (or CLOSE) the MLCB on the generator.

The system will now be operating in its automatic mode. The main utility disconnect can be turned ON (or CLOSED), but to shut the unit off, this complete process must be repeated.

## 3.6 — Manual Transfer Operation

### **⚠ DANGER!**



**DO NOT attempt to activate the transfer switch manually until all power voltage supplies to the switch have been completely turned off. Failure to turn off all power voltage supplies may result in extremely hazardous and possibly fatal electrical shock.**

Prior to automatic operation, manually exercise the transfer switch to verify that there is no interference with proper operation of the mechanism. Manual operation of the transfer switch is required if electronic operation should fail.

### 3.6.1— Transfer to Generator Power Source - 100/200 Amp

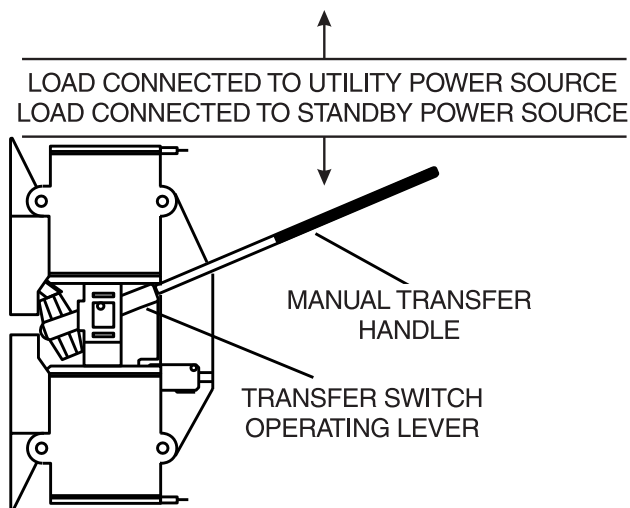

1. Press the Control Panel OFF button.
2. Set the Main Circuit Breaker (Generator Disconnect) to its OFF (OPEN) position.
3. Turn off the utility power supply to the transfer switch using the means provided (such as a utility main line circuit breaker).
4. Use the manual transfer handle inside the transfer switch to move the main contacts to their STANDBY positions (loads connected to the standby power source).
5. To crank and start the engine, press the Control Panel MANUAL button.
6. Allow the engine to stabilize and warm up for a few minutes.
7. Set the Main Circuit Breaker (Generator Disconnect) to its ON (CLOSED) position. The standby power source now powers the loads.

**Figure 3-4: Manual Transfer Switch Operation**

### 3.6.2— Transfer Back to Utility Power Source

When utility power has been restored, transfer back to utility source and shut down the generator. To manually transfer back to utility power and shut down the generator:

1. Set the Main Circuit Breaker (Generator Disconnect) to its OFF (OPEN) position.
2. Allow the engine to run for 2 minutes at no-load to stabilize the internal temperatures.
3. Press the Control Panel OFF button. The engine should shut down.
4. Ensure that utility power supply to the transfer switch is turned off.
5. Use the manual transfer handle inside the transfer switch to move the main contacts back to their UTILITY positions (loads connected to the utility power source).
6. Turn on the utility power supply to the transfer switch using the means provided.
7. Press the Control Panel AUTO button.

### 3.6.3— Transfer to Generator Power Source - 50 Amp

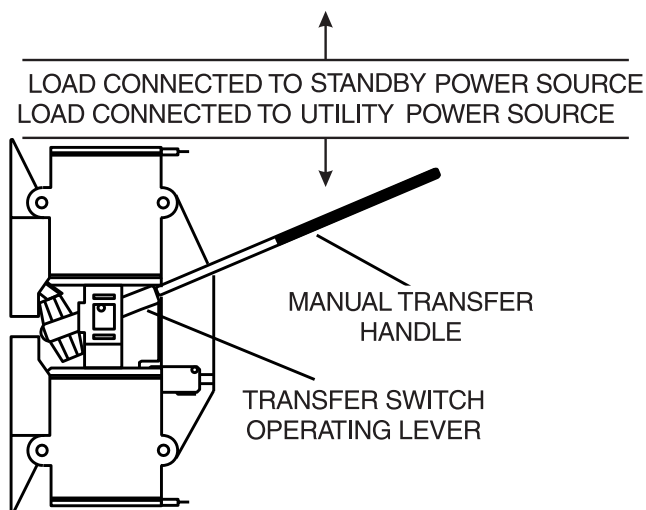

1. Press the Control Panel OFF button.
2. Set the Main Circuit Breaker (Generator Disconnect) to its OFF (OPEN) position.
3. Turn off the utility power supply to the transfer switch using the means provided (such as a utility main line circuit breaker).
4. Use the manual transfer handle inside the transfer switch to move the main contacts to their STANDBY positions (loads connected to the standby power source).
5. To crank and start the engine, press the Control Panel MANUAL button.
6. Allow the engine to stabilize and warm up for a few minutes.
7. Set the Main Circuit Breaker (Generator Disconnect) to its ON (CLOSED) position. The standby power source now powers the loads.

**Figure 3-5: Manual Transfer Switch Operation**

### 3.6.4— Transfer Back to Utility Power Source

When utility power has been restored, transfer back to utility source and shut down the generator. To manually transfer back to utility power and shut down the generator:

1. Set the Main Circuit Breaker (Generator Disconnect) to its OFF (OPEN) position.
2. Allow the engine to run for 2 minutes at no-load to stabilize the internal temperatures.
3. Press the Control Panel OFF button. The engine should shut down.
4. Ensure that utility power supply to the transfer switch is turned off.
5. Use the manual transfer handle inside the transfer switch to move the main contacts back to their UTILITY positions (loads connected to the utility power source).
6. Turn on the utility power supply to the transfer switch using the means provided.
7. Press the Control Panel AUTO button.

## 3.7 — Side Compartment

Local codes may require this compartment to be locked. A hasp is provided so the owner/operator can secure the compartment with his or her own padlock. Check local codes for side compartment locking requirements.

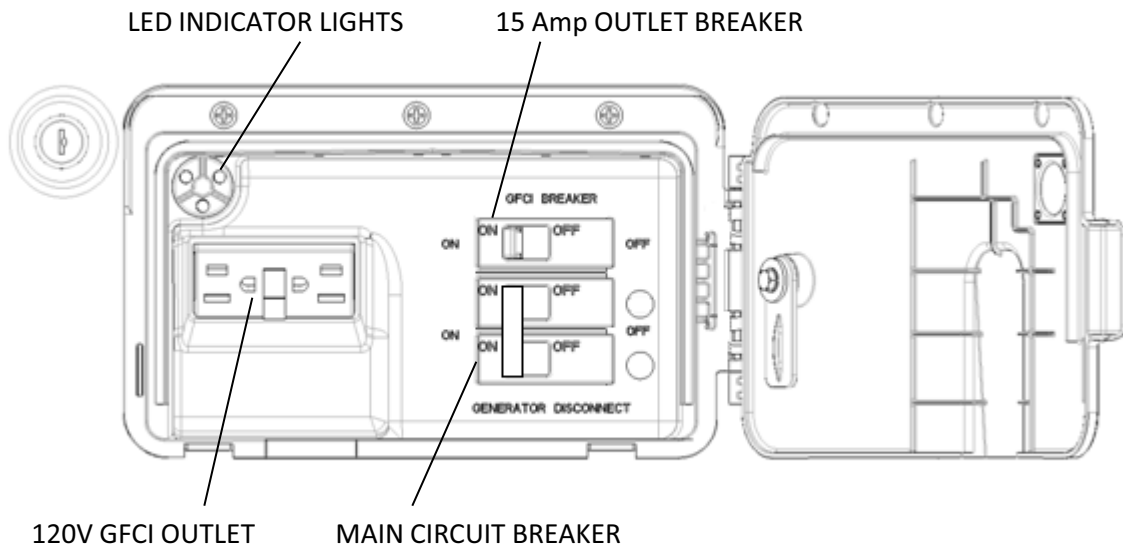

**Figure 3-6: Open Side Compartment**

### 3.7.1— Main Circuit Breaker (Generator Disconnect)

This is a 2-pole breaker rated according to relevant specifications.

### 3.7.2— LED Indicator Lights

- Green LED "Ready" light is on when utility is present and the Control Panel button is in the AUTO position. This also indicates when the generator is running.
- Red LED "Alarm" light is on when the generator is OFF or a fault is detected and means contact your authorized servicing dealer.
- Yellow LED "Maintenance" light. Note: Yellow LED may be on at the same time as either the Red or Green LEDs.

### 3.7.3— 120V GFCI Outlet/15 Amp Breaker (16-22 kW Only)

Some units are equipped with an external 15 amp, 120 volt GFCI convenience outlet located in the top corner of the compartment.

When the generator is running, in the absence of utility power, this outlet may also be used to power items outside the home such as lights or power tools. This outlet may also be used when utility power is present by running the generator in manual mode.

This outlet does not provide power if the generator is not running. Do not use this outlet when the generator is in Exercise mode. This outlet is protected by a 15 Amp circuit breaker in the side compartment.

## 3.8 — Battery Charger

**NOTE:** The battery charger is integrated into the control module in all models.

The battery charger operates as a "Smart Charger" that ensures:

- Output is continually optimized to promote maximum battery life.
- Charging levels are safe.

**NOTE:** A warning is displayed on the LCD when the battery needs service.

### 3.9 — Setting the Exercise Timer

This generator is equipped with a configurable exercise timer. There are two settings for the exercise timer. One is Day/Time. Once it is set, the generator will start and exercise for the period defined, on the day of the week and at the time of day specified. During this exercise period, the unit runs for approximately 5 or 12 minutes, depending on the model, and then shuts down. The other is for the exercise frequency (how often the exercise will take place). It can be set to WEEKLY, BIWEEKLY or MONTHLY. If monthly is chosen, the date of the month must be selected and the generator will exercise on that day each month. Transfer of loads to the generator output does not occur during the exercise cycle unless utility power is lost.

IF THE INSTALLER TESTS THE GENERATOR PRIOR TO INSTALLATION, PRESS THE "ENTER" BUTTON TO SKIP SETTING UP THE EXERCISE TIMER.

Table 3-1 details the exercise information and programming options for all Home Standby generators. Figure 3-7 illustrates the engine speed profile during a typical exercise cycle for 22 kW generators. Figure 3-8 shows the engine speed profile for 16-20 kW generators. 8-11 kW generators exercise at a constant 3600 rpm. While providing the necessary periodic exercise operation, the lower rpm also reduces fuel consumption, engine wear and noise.

**NOTE:** The exercise feature will operate only when the generator is placed in the AUTO mode and will not work unless this procedure is performed. The current date/time will need to be reset every time the 12 volt battery is disconnected and then reconnected, and/or when the fuse is removed

| Generator Size             | 8 kW                     | 11 kW                    | 16 kW / 20 kW            | 22 kW                    |
|----------------------------|--------------------------|--------------------------|--------------------------|--------------------------|
| Low Speed Exercise         | n/a *                    | n/a *                    | 2400 rpm                 | 1950 rpm                 |
| Exercise Frequency Options | Weekly/Bi-Weekly/Monthly | Weekly/Bi-Weekly/Monthly | Weekly/Bi-Weekly/Monthly | Weekly/Bi-Weekly/Monthly |
| Exercise Time Length       | 12 minutes               | 12 minutes               | 5 minutes                | 5 minutes                |

\* exercises at 3600 rpm

**Table 3-1: Generator Exercise Characteristics**

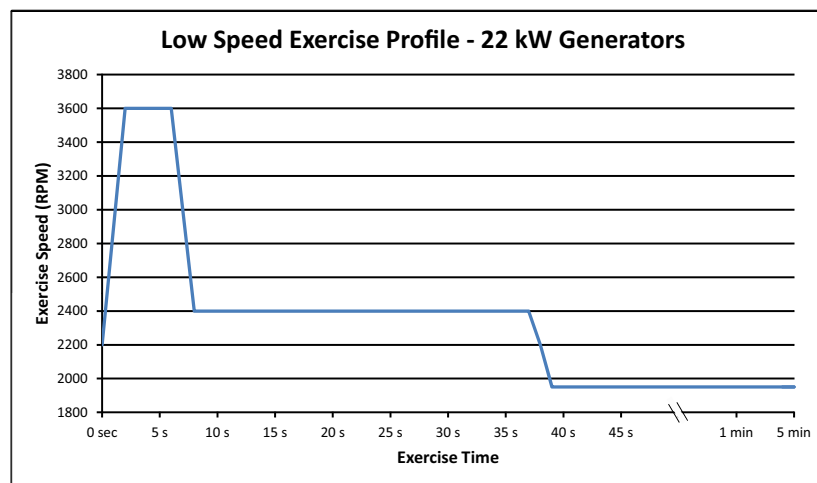

**Figure 3-7: Low Speed Exercise Profile - 22 kW Units**

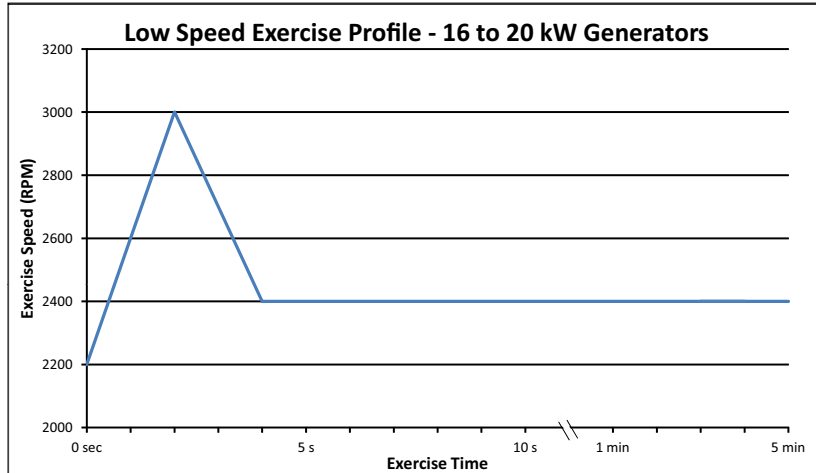

**Figure 3-8: Low Speed Exercise Profile - 16-20 kW units**

NOTE: If your generator came equipped with the Mobile Link monitoring system, don't forget to log onto [standbystatus.com](http://standbystatus.com) to enroll your generator system today!

---

**This page intentionally left blank.**



## Section 4

# Maintenance

NOTE: Proper maintenance and proper and safe operation is crucial to the life of the generator. Genuine Generac parts MUST be used to ensure warranty coverage

NOTE: Since most maintenance alerts occur at the same time (most have two year intervals), only one will appear at any one time. Clearing one will cause the next active alert to be displayed.

### **⚠ WARNING!**



All service work to this generator must be performed by a qualified service person only.

## 4.1 — Performing Scheduled Maintenance

It is important to perform Maintenance as specified in the Service Schedule for proper generator operation and to ensure that the generator complies with the applicable emission standards for the duration of its useful life. Service and repairs may be performed by any qualified service person or repair shop. Additionally, emissions critical maintenance must be performed as scheduled in order for the Emissions Warranty to be valid. Emissions critical maintenance consists of servicing the air filter and spark plugs in accordance with the Service Schedule. The controller will prompt for Schedule A or Schedule B maintenance to be performed. Schedule A maintenance consists of the oil, oil filter and tune-up. Schedule B maintenance includes the oil, oil filter, tune-up, air cleaner, spark plug(s) and valve clearance.

## 4.2 — Service Schedule

| System Component  | Procedure                                  |        |       | Frequency                               |
|---|--|--------|-------|---|
|   | Inspect                                    | Change | Clean |   |
| X = Action<br>R= Replace as Necessary<br>* = Notify Dealer if Repair is Needed  |  |        |       | W = Weekly<br>M = Monthly<br>Y = Yearly |
| <b>Fuel</b>   |  |        |       |   |
| Fuel lines and connections*   | X  |        |       | M                                       |
| <b>Lubrication</b>  |  |        |       |   |
| Oil level   | X  |        |       | M or 24 hours of continuous operation   |
| Oil   |  | X      |       | 2Y or 200 hours of operation**          |
| Oil filter  |  | X      |       | 2Y or 200 hours of operation**          |
| <b>Cooling</b>  |  |        |       |   |
| Enclosure louvers   | X  |        | X     | W                                       |
| <b>Battery</b>  |  |        |       |   |
| Remove corrosion, ensure dryness  | X  |        | X     | Y                                       |
| Clean and tighten battery terminals   | X  |        | X     | Y                                       |
| Check charge state  | X  | X      |       | Y                                       |
| Electrolyte level (unsealed batteries only)*  | X  | X      |       | Every 6 M                               |
| <b>Engine and Mounting</b>  |  |        |       |   |
| Air cleaner   | X  | X      |       | 400 hours                               |
| Spark plug(s)   | X  | X      |       | 400 hours                               |
| Valve Clearance   | X  |        |       | 400 hours***                            |
| <b>General Condition</b>  |  |        |       |   |
| Vibration, Noise, Leakage*  | X  |        |       | M                                       |
| <b>Complete Tune-Up*</b>  | Independent Authorized Dealer must perform |        |       | 2Y or 200 hours                         |
| * Contact the nearest Dealer for assistance if necessary.<br>** Change oil and filter after the first 25 hours of operation. Continue to check at intervals of 200 hours or 2 years, whichever occurs first. Severe duty oil drain intervals: In cold weather conditions (ambient below 40 °F/4.4 °C) change engine oil and filter every year or 100 hours of operation to prevent accumulation of water in the oil. If the unit will be operated continuously in hot ambient conditions (ambient above 85 °F/29.4 °C), change every year or 100 hours of operation.<br>*** Check valve clearance after the first 25 hours of operation. Continue to check at intervals of 400 hours. |  |        |       |   |

---

### 4.2.1— Maintenance Log

1. Battery inspection and charge check (recommended every year (1) for the life of the battery)

NOTE: Check electrolyte level (unsealed batteries only) every 6 months.

Dates Performed:

|  |  |  |  |  |  |  |  |  |  |
|--|--|--|--|--|--|--|--|--|--|
|  |  |  |  |  |  |  |  |  |  |
|  |  |  |  |  |  |  |  |  |  |
|  |  |  |  |  |  |  |  |  |  |

2. Oil, oil filter and air filter replacement (recommended after the first 25 hours after installation and every 200 hours or 2 years, whichever occurs first) NOTE: Spark plug replacement (recommended every 4 years or 400 hours, whichever occurs first).

Dates Performed:

|  |  |  |  |  |  |  |  |  |  |
|--|--|--|--|--|--|--|--|--|--|
|  |  |  |  |  |  |  |  |  |  |
|  |  |  |  |  |  |  |  |  |  |
|  |  |  |  |  |  |  |  |  |  |

3. Valve Adjustment (recommended after the first 25 hours of operation and then after every 400 hours of operation)

Dates Performed:

|  |  |  |  |  |  |  |  |  |  |
|--|--|--|--|--|--|--|--|--|--|
|  |  |  |  |  |  |  |  |  |  |
|  |  |  |  |  |  |  |  |  |  |
|  |  |  |  |  |  |  |  |  |  |

### 4.3 — Checking Engine Oil Level

When power outages necessitate running the generator for extended periods, the oil level should be checked daily. To check the engine oil level:

1. If the generator is running during a utility outage, first turn OFF all associated loads running in the residence using the electrical panel's main disconnect. Then, turn the generator's Main Circuit Breaker to the OFF position.
2. Press the Control Panel OFF button. Wait 5 minutes.
3. Remove the dipstick and wipe it dry with a clean cloth.
4. Completely insert the dipstick and again remove it.
5. Observe the oil level. The level should be at the "Full" mark on the dipstick.
6. If necessary, remove the oil fill cap and add oil to the engine until the level reaches the "Full" mark and reinsert the dipstick and fill cap.
7. Press the Control Panel AUTO button.
8. If the generator was running during a utility outage, first turn the Main Circuit Breaker to the ON position. Then, turn ON the needed loads in the residence.

**⚠ DANGER!**



Never operate the engine with the oil level below the "Add" mark on the dipstick. Doing so could damage the engine.



Hot oil may cause burns. Avoid prolonged or repeated skin exposure with used oil. Thoroughly wash exposed areas with soap.

### 4.3.1— Engine Oil Recommendations

To maintain the warranty, genuine Generac replacement parts **MUST** be used, including Generac oil kits (which include an oil and air filter). Generac oil kits can be obtained through an Authorized Dealer or purchased on-line. To purchase on-line, access the maintenance kits page through [www.generac.com](http://www.generac.com) or directly at [shop.generac.com](http://shop.generac.com). Follow the prompts to enter delivery information and complete the purchase.

All Generac oil kits meet minimum American Petroleum Institute (API) Service Class SJ, SL, or better. Use no special additives. Select the appropriate viscosity oil grade according to the expected operating temperature. Synthetic oil also can be used in the appropriate weight as standard.

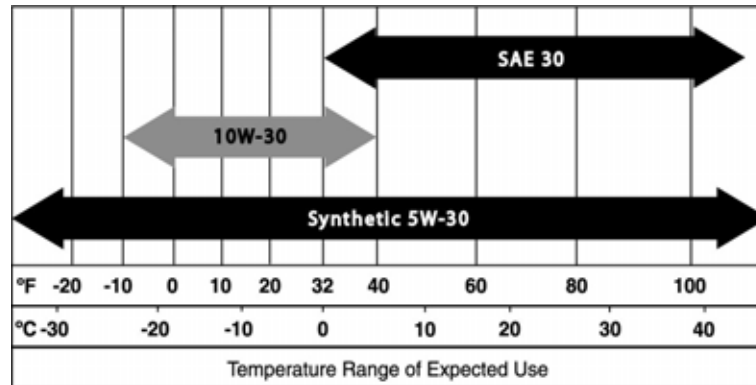

**Figure 4-1: Recommended Oil Based on Temperature**

- SAE 30 above 32 °F (0 °C)
- 10W-30 between 40 and -10 °F (4 and -23 °C)
- Synthetic 5W-30 for all temperature ranges

**⚠ WARNING!**



Any attempt to crank or start the engine before it has been properly serviced with the recommended oil may result in an engine failure.

### 4.3.2— Changing the Oil and Oil Filter

1. Start the engine by pressing the MANUAL button on the control panel and allow the engine to run for 5 minutes. Then, press the Control Panel OFF button to shut down the engine.
2. A few minutes after the engine shuts OFF, when it has cooled slightly, lift the lid and remove the front panel. Pull the oil drain hose free of its retaining clip. Remove the cap from the hose and drain the oil into a suitable container.
3. After the oil has drained, replace the cap onto the end of the oil drain hose. Reposition and secure the hose with the retaining clip.
4. With the oil drained, remove the old oil filter by turning it counterclockwise. For filter location, see Figure 4-2.
5. Apply a light coating of clean engine oil to the gasket of the new filter.
6. Screw the new filter on by hand until its gasket lightly contacts the oil filter adapter. Then, tighten the filter an additional 3/4 to one full turn.
7. Refill the engine with the proper recommended oil. For recommended oil, see Figure 4-1.
8. Start the engine, run for 1 minute, and check for leaks.
9. Shutdown the engine and recheck the oil level. Add oil as needed. **DO NOT OVER FILL.**
10. Re-insert dipstick and/or reattach fill cap.
11. Press the Control Panel AUTO button.
12. Dispose of the used oil and filter at a proper collection center.

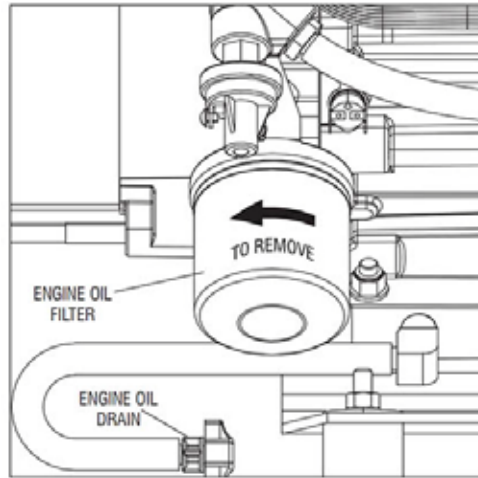

**Figure 4-2: Oil Filter and Drain Location**

## **4.4 — Changing the Engine Air Cleaner**

1. With the generator shut down, lift the lid and remove the front panel.
2. Remove the cover clips and air cleaner cover (11-22 kW), or disengage the wire clip and open the air cleaner access door (8 kW).
3. Pull out the old air filter and discard.
4. Thoroughly clean the air cleaner enclosure of any dust or debris.
5. Install a new air cleaner.
6. Install the air cleaner cover and cover clips (11-22 kW), or close the air cleaner access door and engage the wire clip (8 kW).

## **4.5 — Spark Plugs**

Reset the spark plug(s) gap or replace the spark plug(s) as necessary:

1. With the generator shut down, lift the lid and remove the front panel.
2. Clean the area around the base of the spark plug(s) to keep dirt and debris out of the engine.
3. Remove the spark plug(s) and check the condition. Install a new plug(s) if the old one is worn or if reuse is questionable.
4. Clean the plug(s) by scraping or washing with a wire brush and commercial solvent. Do not blast the plug(s) to clean.
5. Check the spark plug gap using a wire feeler gauge. See Figure 4-3. Adjust the gap by carefully bending the ground electrode to:
  - For 8, 11, 20 and 22 kW units - 0.76 mm (0.030 in)
  - For 16 kW units - 1.02 mm (0.040 in)

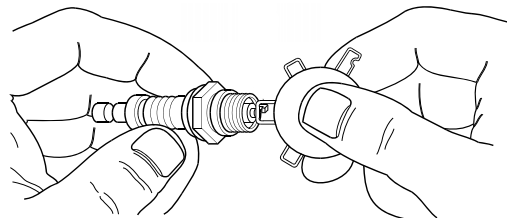

**Figure 4-3: Spark Plug Gap Adjustment**

---

## 4.6 — Valve Lash Adjustment

After the first 25 hours of operation and then after every 400 hours of operation, check the valve clearance. Adjust if necessary.

Important: Please contact the Dealer for service assistance. This is a very important step to ensure longest life for the engine.

To check valve clearance:

- The engine should be cool before checking. If valve clearance is 0.002 - 0.004 in (0.05 - 0.1 mm), adjustment is not needed.
- Remove spark plug wires and position wires away from plugs.
- Remove spark plugs.
- Make sure the piston is at Top Dead Center (TDC) of its compression stroke (both valves closed). To get the piston at TDC, remove the intake screen at the front of the engine to gain access to the flywheel nut. Use a large socket and socket wrench to rotate the nut and hence the engine in a clockwise direction. While watching the piston through the spark plug hole. The piston should move up and down. The piston is at TDC when it is at its highest point of travel.

To adjust valve clearance (see Figure 4-4):

- Make sure the engine is at 60 ° to 80 °F (16 ° to 27 °C).
- Make sure that the spark plug wire is removed from the spark plug and out of the way.
- Remove the four screws attaching the valve cover.
- Loosen the rocker jam nut. Using a 10 mm Allen wrench (530 cc engine) or a 13 mm Allen wrench (410 cc, 990 cc and 999 cc engines), turn the pivot ball stud while checking clearance between the rocker arm and the valve stem with a feeler gauge. Correct clearance is 0.002-0.004 in (0.05-0.1 mm).

**NOTE: Hold the rocker arm jam nut in place as the pivot ball stud is turned.**

- When valve clearance is correct, hold the pivot ball stud in place with the Allen wrench and tighten the rocker arm jam nut. Tighten the jam nut to 174 in-lb (19.68 N-m) torque. After tightening the jam nut, recheck valve clearance to make sure it did not change.
- Install new valve cover gasket.
- Re-attach the valve cover.

**NOTE: Start all four screws before tightening or it will not be possible to get all the screws in place. Make sure the valve cover gasket is in place.**

- Torque fasteners to 6-9 ft/lb (8-12 Nm)
- Install spark plugs. Torque to 15-18 ft/lb (20-25 Nm).
- Re-attach the spark plug wire to the spark plug.
- Repeat the process for the other cylinder, if necessary.

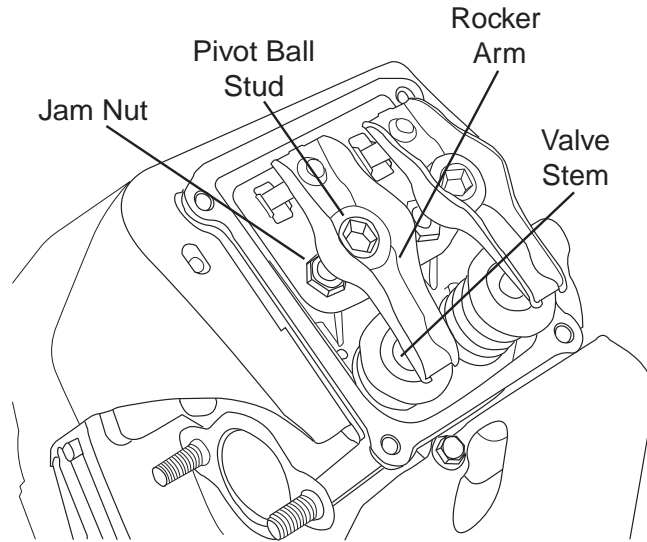

**Figure 4-4: Valve Clearance Adjustment**

## 4.7 — Battery Maintenance

The battery should be regularly inspected per the Service Schedule:

1. With the generator shut down, lift the lid and remove the front panel.
2. Inspect the battery posts and cables for tightness and corrosion. Tighten and clean as necessary.
3. Check the battery fluid level of unsealed batteries, and if necessary, fill with distilled water only. DO NOT use tap water. Also, have the Dealer or a qualified Service Technician check the state of charge and condition.

### **⚠ DANGER!**



Do not dispose of the battery by incineration. The battery is capable of exploding.



A battery presents a risk of electrical shock and high short circuit current. Strictly observe the following precautions when working on batteries:

- Remove the 7.5 Amp ATO<sup>®</sup> fuse from the generator control panel.
- Remove all jewelry—watches, rings, metal objects, etc.
- Use tools with insulated handles.
- Wear rubber gloves and boots.
- Do not lay tools or metallic objects on top of the battery.
- Disconnect the charging source prior to connecting or disconnecting battery terminals.

---

**⚠ DANGER!**

**Do not open or mutilate the battery. Released electrolyte has been known to be harmful to the skin and eyes, and to be toxic. The electrolyte is a dilute sulfuric acid that is harmful to the skin and eyes. It is electrically conductive and corrosive. Strictly observe the following precautions:**

- Wear full eye protection and protective clothing.
- Where electrolyte contacts the skin, wash it off immediately with water.
- Where electrolyte contacts the eyes, flush thoroughly and immediately with water and seek medical attention.
- Wash down spilled electrolyte with an acid neutralizing agent. A common practice is to use a solution of 1 pound (500 grams) bicarbonate of soda to 1 gallon (4 liters) of water. The bicarbonate of soda solution is to be added until the evidence of reaction (foaming) has ceased. The resulting liquid is to be flushed with water and the area dried.



**Lead-acid batteries present a risk of fire because they generate hydrogen gas. Strictly observe the following precautions:**

- DO NOT smoke when near the battery.
- DO NOT cause flame or spark in the battery area.
- Discharge static electricity from the body before touching the battery by first touching a grounded metal surface.



**Be sure the utility power supply is turned off and the 7.5 Amp fuse is removed from the generator Control Panel, or sparking may occur at the battery posts as the cables are attached and cause an explosion.**

## **4.8 — Attention After Submersion**

If the generator has been submerged in water, it **MUST NOT** be started and operated. Following any submersion in water, have a Dealer thoroughly clean, dry, and inspect the generator. If the structure (home) has been flooded, it should be inspected by a certified electrician to ensure there won't be any electrical problems during generator operation or when utility power is returned.

## **4.9 — Corrosion Protection**

Periodically wash and wax the enclosure using automotive type products. Frequent washing is recommended in salt water/coastal areas. Spray engine linkages with a light oil such as WD-40.

## **4.10 — Out of Service Procedure**

### **4.10.1— Removal From Service**

If the generator cannot be exercised every 7 days and will be out of service longer than 90 days, prepare the generator for storage:

1. Start the engine and let it warm up.
2. Close the fuel shutoff valve in the fuel supply line and allow the unit to shut down.
3. Once the unit has shut down, set the generator's Main Circuit Breaker (Generator Disconnect) to its OFF (OPEN) position.
4. Turn off the utility power to the transfer switch.
5. Remove the 7.5 Amp ATO<sup>®</sup> fuse from the generator's Control Panel.
6. Disconnect the battery cables. Remove negative cable first.
7. Remove battery charger AC input T1/Neutral cable (has white sleeve) at controller.
8. While the engine is still warm, drain the oil completely, and then refill the crankcase with oil.
9. Attach a tag to the engine indicating the viscosity and classification of the new oil in the crankcase.
10. Remove the spark plug(s) and spray a fogging agent into the spark plug(s)' threaded openings. Reinstall and tighten the spark plug(s).
11. Remove the battery and store it in a cool, dry room on a wooden board. Never store the battery on any concrete or earthen floor.
12. Clean and wipe down the entire generator.

---

## 4.10.2— Return to Service

To return the unit to service after storage:

1. Verify that utility power is turned off.
2. Check the tag on the engine for oil viscosity and classification. If necessary, drain and refill with proper oil.
3. Check the state of the battery. Fill all cells of unsealed batteries to the proper level with distilled water. DO NOT use tap water. Recharge the battery to 100% state of charge. If defective, replace the battery.
4. Clean and wipe down the entire generator.
5. Make sure the 7.5 Amp ATO<sup>®</sup> fuse is removed from the generator Control Panel.
6. Reconnect the battery. Observe battery polarity. Damage may occur if the battery is connected incorrectly. Install positive cable first.
7. Reconnect the battery charger AC input T1/Neutral cable (has white sleeve) at controller.
8. Open the fuel shutoff valve.
9. Insert the 7.5 Amp ATO<sup>®</sup> fuse into the generator Control Panel.
10. Start the unit by pressing the MANUAL button. Allow the unit to warm up for a few minutes.
11. Stop the unit by pressing the Control Panel OFF button.
12. Turn on the utility power to the transfer switch.
13. Set the Control Panel to AUTO.

The generator is ready for service.

**NOTE:** When a battery is dead or has been disconnected, the exercise timer and current date and time must be reset.



---

## Section 5

# Troubleshooting

---

| <b>Problem</b>  | <b>Cause</b>  | <b>Correction</b>   |
|---|---|---|
| The engine will not crank.                                    | <ol style="list-style-type: none"><li>1. Fuse blown.</li><li>2. Loose, corroded or defective battery cables.</li><li>3. Defective starter contact.</li><li>4. Defective starter motor.</li><li>5. Dead Battery.</li></ol>   | <ol style="list-style-type: none"><li>1. Correct short circuit condition by replacing 7.5 Amp fuse in generator control panel.</li><li>2. Tighten, clean or replace as necessary.*</li><li>3. *See #2.</li><li>4. *See #2.</li><li>5. Charge or replace battery.</li></ol>  |
| The engine cranks but will not start.                         | <ol style="list-style-type: none"><li>1. Out of fuel.</li><li>2. Defective fuel solenoid (FS).</li><li>3. Defective spark plug(s).</li><li>4. Valve lash out of adjustment.</li></ol>   | <ol style="list-style-type: none"><li>1. Replenish fuel/Turn on fuel valve.</li><li>2. *</li><li>3. Clean, re-gap or replace plug(s).</li><li>4. Reset valve lash.</li></ol>  |
| The engine starts hard and runs rough.                        | <ol style="list-style-type: none"><li>1. Air cleaner plugged or damaged.</li><li>2. Defective spark plug(s).</li><li>3. Fuel pressure incorrect.</li><li>4. Fuel selector in wrong position.</li></ol>  | <ol style="list-style-type: none"><li>1. Check/replace air cleaner.</li><li>2. Clean, re-gap or replace plug(s).</li><li>3. Confirm fuel pressure to regulator is 10-12" water column (19-22 mm mercury) for LP, and 3.5-7" water column (7-13 mm mercury) for natural gas.</li><li>4. Move selector to correct position.</li></ol> |
| The generator is set to OFF, but the engine continues to run. | <ol style="list-style-type: none"><li>1. Controller wired incorrectly.</li><li>2. Defective control board</li></ol>   | <ol style="list-style-type: none"><li>1. Repair wiring or replace controller*</li><li>2. Replace controller.</li></ol>  |
| There is no AC output from the generator.                     | <ol style="list-style-type: none"><li>1. Main line circuit breaker is in the OFF (or OPEN) position.</li><li>2. Generator internal failure.</li></ol>   | <ol style="list-style-type: none"><li>1. Reset circuit breaker to ON (or CLOSED).</li><li>2. *</li></ol>  |
| There is no transfer to standby after utility source failure. | <ol style="list-style-type: none"><li>1. Main line circuit breaker is in the OFF (or OPEN) position.</li><li>3. Defective transfer switch coil.</li><li>4. Defective transfer relay</li><li>5. Transfer relay circuit open.</li><li>5. Defective control logic board.</li></ol> | <ol style="list-style-type: none"><li>1. Reset circuit breaker to ON (or CLOSED) position.</li><li>3. *</li><li>4. *</li><li>5. *</li><li>5. *</li></ol>  |
| Unit consumes large amounts of oil.                           | <ol style="list-style-type: none"><li>1. Engine over filled with oil.</li><li>2. Engine breather defective.</li><li>3. Improper type or viscosity of oil.</li><li>4. Damaged gasket, seal or hose.</li></ol>  | <ol style="list-style-type: none"><li>1. Adjust oil to proper level.</li><li>2. *</li><li>3. See "Engine Oil Recommendations".</li><li>4. Check for oil leaks.</li></ol>  |

**\*Contact an Authorized Service Dealer for assistance.**

---

**This page intentionally left blank.**

| Active Alarm          | Problem   | LED   | Things to Check                         | Solution  |
|-----------------------|---|-------|---|---|
| NONE                  | Unit running in AUTO but no power in house.           | GREEN | Check MLCB.                             | Check MLCB. Contact servicing dealer if MLCB is in the ON position.   |
| HIGH TEMPERATURE      | Unit shuts down during operation.                     | RED   | Check the LEDs/Screen for alarms.       | Check ventilation around the intake, exhaust and rear of generator. Contact servicing dealer if no obstruction is found.  |
| OVERLOAD REMOVE LOAD  | Unit shuts down during operation.                     | RED   | Check the LEDs/Screen for alarms.       | Clear alarm and remove household loads from the generator. Put back in AUTO and restart.  |
| RPM SENSE LOSS        | Unit was running and shuts down, attempts to restart. | RED   | Check the LEDs/Screen for alarms.       | Clear alarm and remove household loads from the generator. Put back in AUTO and restart. If problem returns, contact servicing dealer to investigate possible fuel issue.       |
| NOT ACTIVATED         | Unit will not start in AUTO with utility loss.        | NONE  | See if screen says unit not activated.  | Refer to activation section in Owner's Manual.  |
| None                  | Unit will not start in AUTO with utility loss.        | GREEN | Check screen for start delay countdown. | If the start up delay is greater than expected, contact servicing dealer to adjust from 2 to 1500 seconds.  |
| LOW OIL PRESSURE      | Unit will not start in AUTO with utility loss.        | RED   | Check the LEDs/Screen for alarms.       | Check oil level. Add oil per Owner's Manual. Contact servicing dealer if oil level is correct.  |
| RPM SENSE LOSS        | Unit will not start in AUTO with utility loss.        | RED   | Check the LEDs/Screen for alarms.       | Clear alarm. From the MAIN menu on the control panel, navigate to the BATTERY MENU. Contact servicing dealer if battery is GOOD. Replace battery if CHECK BATTERY is displayed. |
| OVERCRANK             | Unit will not start in AUTO with utility loss.        | RED   | Check the LEDs/Screen for alarms.       | Check fuel line shutoff valve is in the ON position. Clear alarm. Attempt to start the unit in MANUAL. If it does not start or starts and runs rough, contact servicing dealer. |
| LOW VOLTS REMOVE LOAD | Unit will not start in AUTO with utility loss.        | RED   | Check the LEDs/Screen for alarms.       | Clear alarm and remove household loads from the generator. Put back in AUTO and restart.  |
| FUSE PROBLEM          | Unit will not start in AUTO with utility loss.        | RED   | Check the LEDs/Screen for alarms.       | Check ATO 7.5 Amp fuse. Replace with same type fuse if bad. Contact servicing dealer if fuse is good.   |
| OVERSPEED             | Unit will not start in AUTO with utility loss.        | RED   | Check the LEDs/Screen for alarms.       | Contact servicing dealer.   |
| UNDER VOLTAGE         | Unit will not start in AUTO with utility loss.        | RED   | Check the LEDs/Screen for alarms.       | Contact servicing dealer.   |
| UNDERSPEED            | Unit will not start in AUTO with utility loss.        | RED   | Check the LEDs/Screen for alarms.       | Contact servicing dealer.   |

| <b>Active Alarm</b> | <b>Problem</b>                                 | <b>LED</b> | <b>Things to Check</b>                   | <b>Solution</b>   |
|---------------------|--|------------|--|---|
| STEPPER OVERCURRENT | Unit will not start in AUTO with utility loss. | RED        | Check the LEDs/Screen for alarms.        | Contact servicing dealer.   |
| MISWIRE             | Unit will not start in AUTO with utility loss. | RED        | Check the LEDs/Screen for alarms.        | Contact servicing dealer.   |
| OVERVOLTAGE         | Unit will not start in AUTO with utility loss. | RED        | Check the LEDs/Screen for alarms.        | Contact servicing dealer.   |
| LOW BATTERY         | Yellow LED illuminated in any state.           | YELLOW     | Check screen for additional information. | Clear alarm. From the MAIN menu on the control panel, navigate to the BATTERY MENU. Contact servicing dealer if battery is GOOD. Replace battery if CHECK BATTERY is displayed. |
| BATTERY PROBLEM     | Yellow LED illuminated in any state.           | YELLOW     | Check screen for additional information. | Contact servicing dealer.   |
| CHARGER WARNING     | Yellow LED illuminated in any state.           | YELLOW     | Check screen for additional information. | Contact servicing dealer  |
| SERVICE A           | Yellow LED illuminated in any state.           | YELLOW     | Check screen for additional information. | Perform SERVICE A maintenance; press ENTER to clear.  |
| SERVICE B           | Yellow LED illuminated in any state.           | YELLOW     | Check screen for additional information. | Perform SERVICE B maintenance; press ENTER to clear.  |
| Inspect Battery     | Yellow LED illuminated in any state.           | YELLOW     | Check screen for additional information. | Inspect battery; press ENTER to clear.  |



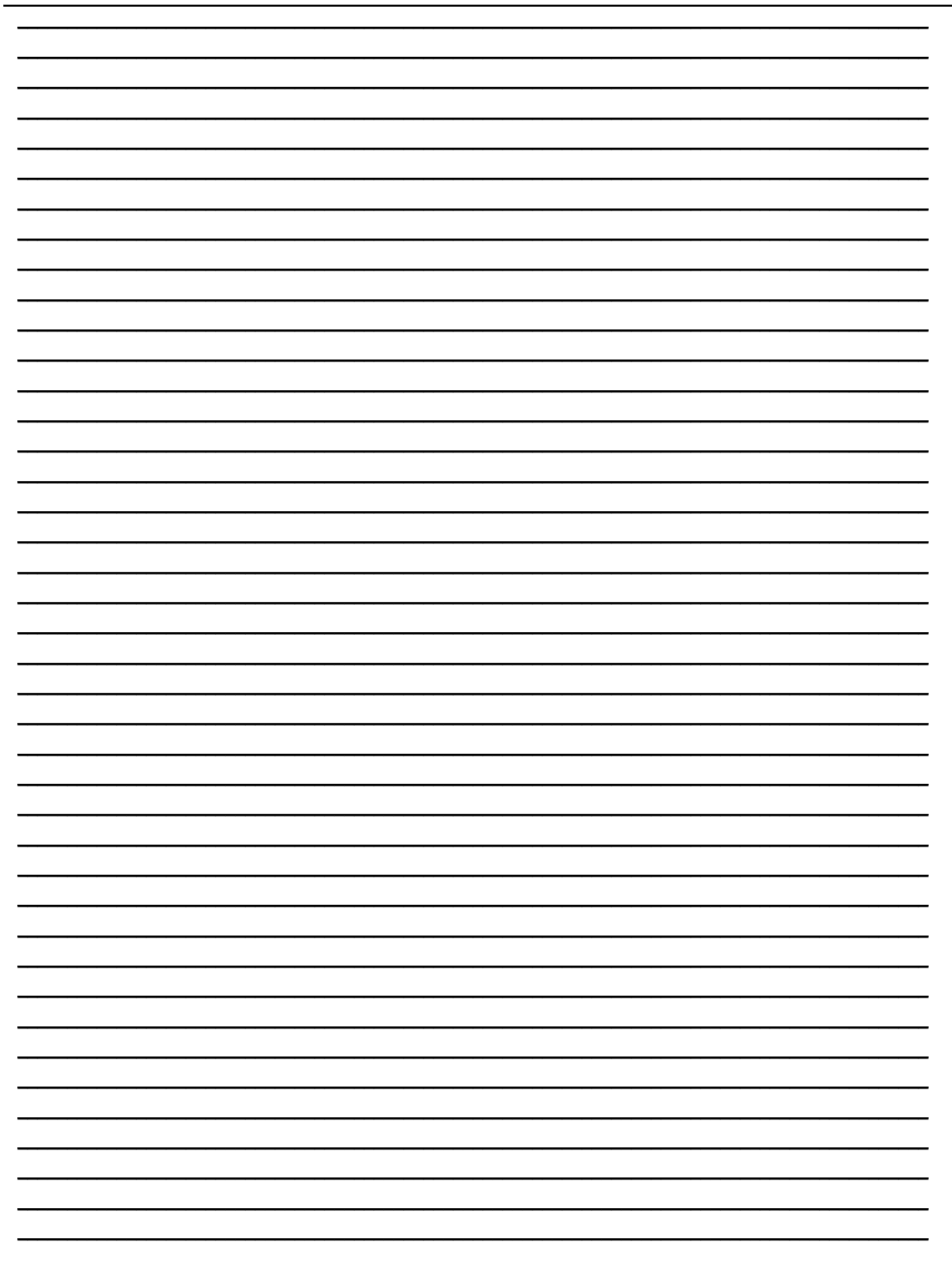



Generac Power Systems  
S45 W29290 Hwy 59  
Waukesha, WI 53187  
1-855-GEN-INFO  
honeywellgenerators.com

# Honeywell

The Honeywell trademark is used under license from Honeywell International Inc. Honeywell International Inc. makes no representation or warranties with respect to this product.

Part No. 0K5801Y12

Revision B (05/28/14)

Printed in U.S.A.