

**GENERAC®**



**PWR** **VIEW**

WELCOME GUIDE

# Welcome

This booklet will guide you through the installation process of the Generac PWRView, which will include downloading and registering on the PWRView Installer App. These instructions will focus on a 120/240 V single phase system (also known as a split-phase system), the most common power system in North America. If you have a single phase, 3-phase, or solar system, please visit [www.generac.com/service-support/PWRview](http://www.generac.com/service-support/PWRview) for instructions.

## CONNECTING TO THE PWRVIEW INSTALLER APP

Please download the PWRview Installer App on your smartphone. The PWRview Installer App is available on the App Store and Google Play. Open the PWRview Installer App on your phone and follow the instructions to register. The PWRview Installer App will help to guide you through the install and confirm the system is working correctly.

## ITEMS NEEDED BEFORE STARTING:

- Smartphone
- Flashlight
- Thick insulated rubber gloves
- Screwdrivers
- Pliers
- Two empty breakers  
(or one two-pole breaker)\*

**\*NOTE:** The voltage cables on the PWRview Meter need to be installed on two empty breakers (one for each phase) or one empty dual (double) pole breaker. However, some regional codes allow you to piggyback wires on existing breakers by using the supplied wiretaps and attaching the voltage wires from PWRview to the existing cables before they go into a breaker. See Step 3 for diagrams. Please consult your local electrical code for approved methods.



**WARNING:** Installing PWRview requires working with voltages that may cause serious bodily injury or even death, and thus should only be done by a qualified professional. Installations should be performed in accordance with the applicable electrical code for the region in which PWRview is being installed. Whenever possible, power should be disconnected upstream from the installation location before attempting installation of PWRview. If power cannot be disconnected, high voltages may still be present, and warning must be taken to avoid injury. If PWRview is not used as instructed, its protection mechanisms may be impaired.

## WHAT'S INCLUDED



PWRview Meter



Voltage Cable



Mounting Plate

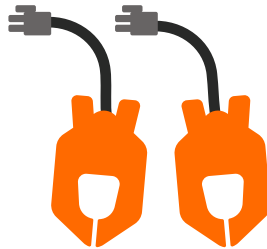

Current Transformers x2



Antenna and cable



Antenna Mounts x2

## ALSO INCLUDED

Wire Nut x1

Wiretaps x3

Screws x2

Cable Ties x2

Jumper Wires x3

Generac Sticker

# Steps to follow:

## Step 1

Remove the panel cover

## Step 2

Mount the PWRview

## Step 3

Connect the voltage cable

## Step 4

Connect the CTs

## Step 5

Connect the antenna

## Step 6

Connect the PWRview

## Step 7

Check your work

## Step 8

Connect to the PWRview App

## Step 9

Replace the panel cover

If you get stuck at any point, visit [www.generac.com/service-support/PWRview](http://www.generac.com/service-support/PWRview) for walkthrough videos and helpful tips.

# Step 1

## REMOVE PANEL COVER

Turn off the main breaker. Remove the screws on the corners of the panel, then remove the cover. After opening the panel, you should see the wires going into each breaker and main lines from the utility.

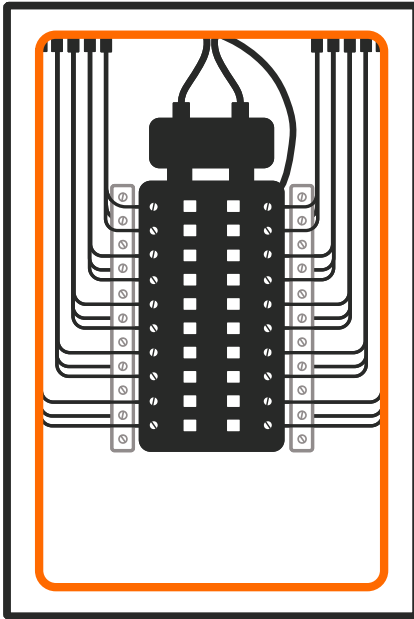

### **DANGER:**

Electrocution. Even with the main breaker in the 'OFF' position the potential for energized wires exists. The main utility lines and connections will be exposed and energized.

If your panel has a secondary cover that hides the main utility line, please remove that as well.

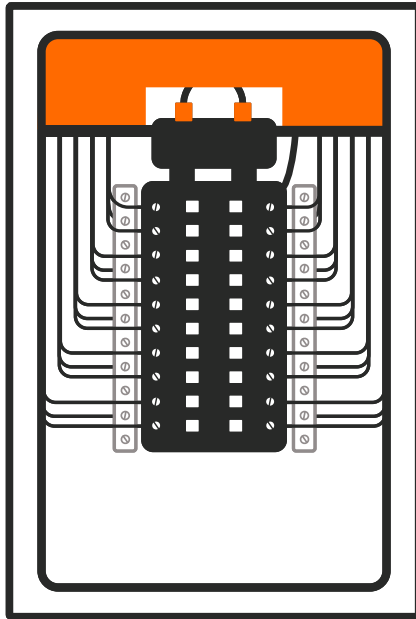

## Step 2

### MOUNT THE PWRVIEW

Find an empty space in the panel where PWRview can comfortably fit. Secure the mounting plate to your panel. Ensure that there is enough room for the wiring to reach PWRview once it's clipped into place, but do NOT clip it into place yet.

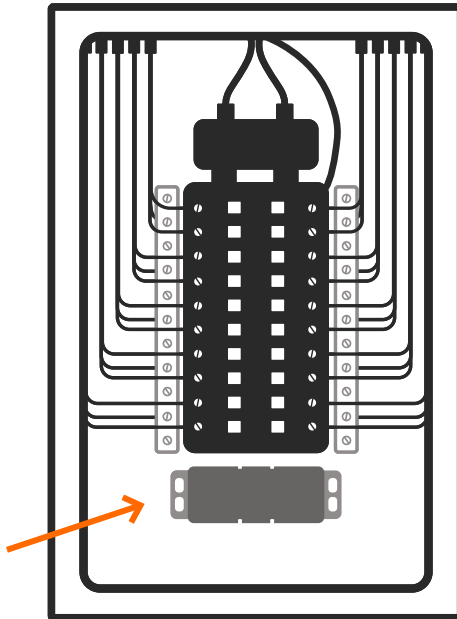

**NOTE:** The self-drilling screws will need pressure to drill through the metal. You can also drill a pilot hole to make it easier. Just be sure you use a 1/8" or smaller drill bit.





**NOTE:** Be sure to account for the length of the CTs and the 2-foot voltage cable, and ensure that there is enough room on the sides of PWRview for the wires and antenna to connect to.

# Step 3

## CONNECT THE VOLTAGE CABLE

Connect the black and red wires to a 2 pole 15A or 20A circuit breaker. The black wire should go to Phase A and the red to Phase B. Connect the white wire to the neutral bus bar usually located next to the breaker

**NOTE:** The blue wire is only needed when connecting a CT to Port 3, which is not used in a 2-phase, consumption only installation. If the blue wire is not needed, twist the wire nut onto the blue wire. For more installation types, visit [www.generac.com/service-support/PWRview](http://www.generac.com/service-support/PWRview)

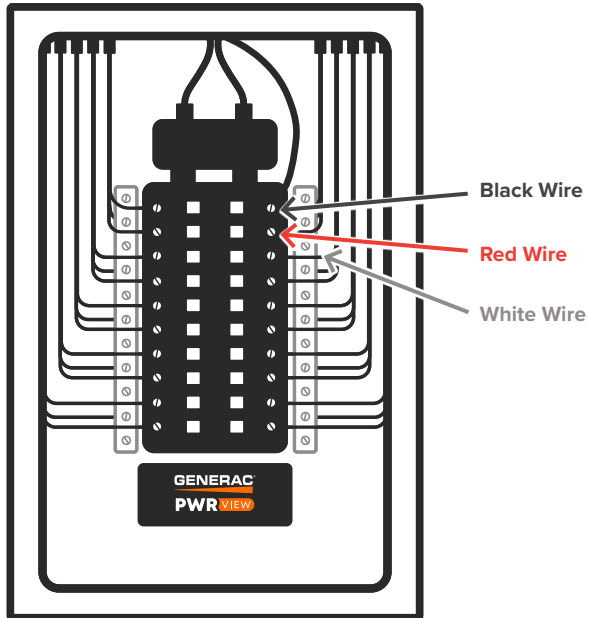

## ALTERNATE WIRING WITH WIRETAP

If an empty breaker isn't available, you can use the provided wiretaps to connect to an existing breaker. To do this, remove the existing wire from the 2 pole 15A or 20A circuit breaker and replace it with the jumper wire provided in the contents of the box. Then take the wiretap and insert the jumper wire, the wire from the PWRview, and the original wire you removed from the breaker. It might take a little force to ensure the wires are secured into the wiretap all the way.

**NOTE:** To remove a wire from the wiretap, simply pull on the wire and twist it.

# Step 4

## CONNECT THE CTS

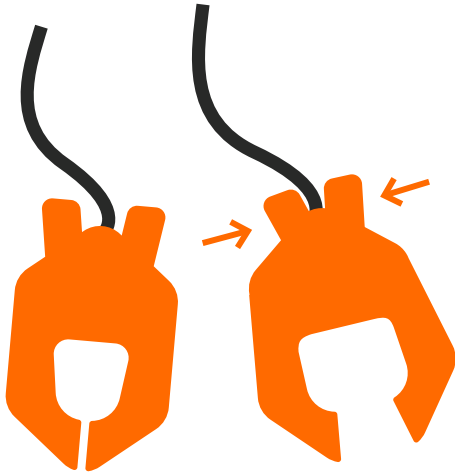

1. For Universal CTs, pinch the handle at the bottom to open the jaws.



**WARNING:** Do not touch the exposed main line connections to the main breaker, as death or serious bodily harm may result.

**NOTE:** Make sure the label on the CT is facing the utility (where the power comes from) and not the breaker panel.

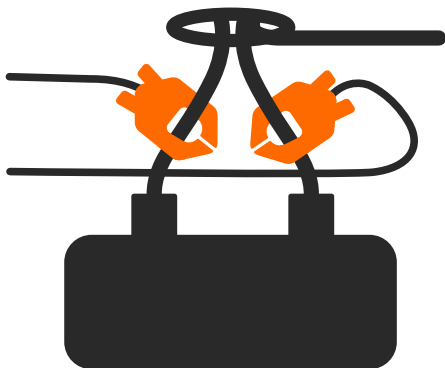

2. Clamp the CT around each of the main power lines. Ensure CT1 goes to Phase A, the same phase for the black voltage wire, CT2 goes to Phase B, the same phase for the red voltage wire. Pay close attention to the direction that the label on the CT is facing; the label should face the utility.

# Step 5

## HOOK UP THE ANTENNA

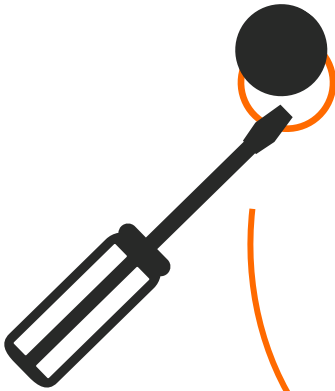

1. Locate the available knockout hole(s) or cover(s) to determine where to use the 3/4" antenna mount. If panel is situated outside, knock should be on the bottom or through back, into wall, to prevent water intrusion.
2. Once you have found a knockout that is the appropriate size, remove the metal to expose the hole. Using a screwdriver or gently tapping with a hammer may be needed.

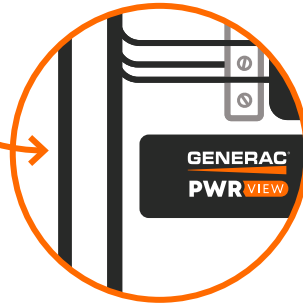

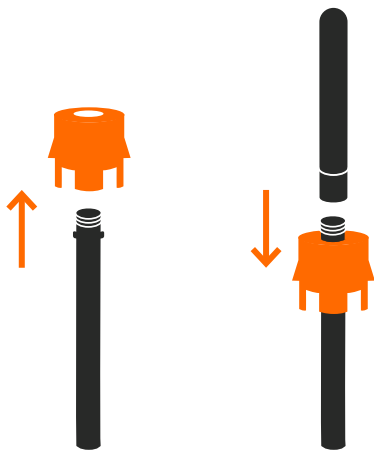

3. Thread the extension cable through the antenna knockout mount, then screw on the antenna.

4. Insert the antenna through the open knockout until the antenna mount clicks into place.

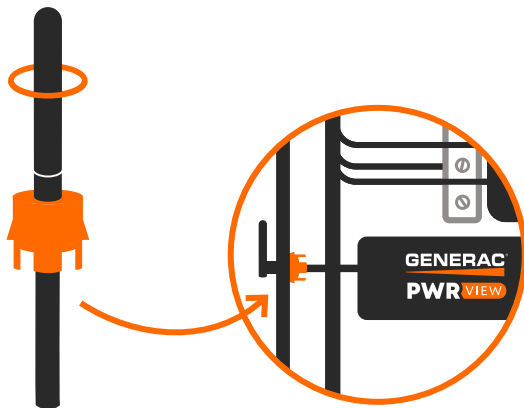

# Step 6

## CONNECT PWRVIEW



1. Connect the antenna extension cable to the side of PWRview.

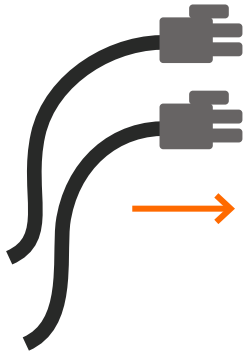

2. Connect the CT's to the appropriate ports on the side of PWRview.



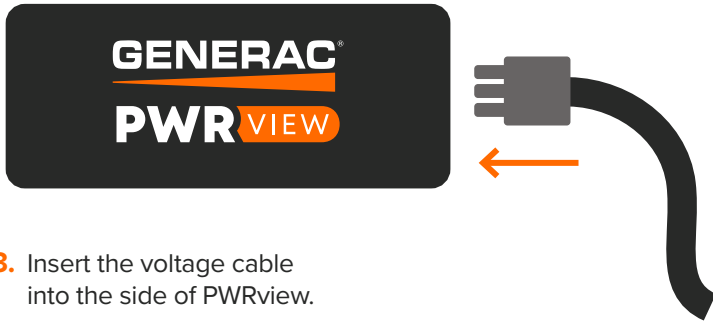

3. Insert the voltage cable into the side of PWRview.
4. Snap PWRview onto the mounting plate.

# Step 7

## REVIEW YOUR WORK

1. PWRview should be mounted firmly in the panel
2. Antenna should be mounted in the knockout with the extension cable connected to the side of PWRview
3. Voltage Cable should be connected properly and securely
  - Black and Red wires to 2 breakers
  - White wire to neutral to bus bar
4. CT Connectors should be connected properly and securely
  - Connectors should be clamped around the mains
  - Make sure the labels are facing the utility
5. Turn the main breaker to the 'ON' position. The next steps will guide you through configuration and confirming the operation of the PWRview meter

PWRVIEW PORT	PWRVIEW CONNECTION	PANEL CONNECTION	PANEL POSITION
Voltage Connector	Black	Empty Breaker 1	Phase A
	Red	Empty Breaker 2	Phase B
	Blue*	No connection	Capped (wire nut)
	White	Neutral Bus bar	NA
Port 1	CT1	Utility line	Phase A
Port 2	CT2	"	Phase B
Port 3*	NA	NA	NA
Port 4*	NA	NA	NA
Antenna connector	Antenna harness	Antenna knockout	Antenna (through encl.)

**NOTE:** These are used for additional installation types. Refer to [www.generac.com/service-support/PWRview](http://www.generac.com/service-support/PWRview)

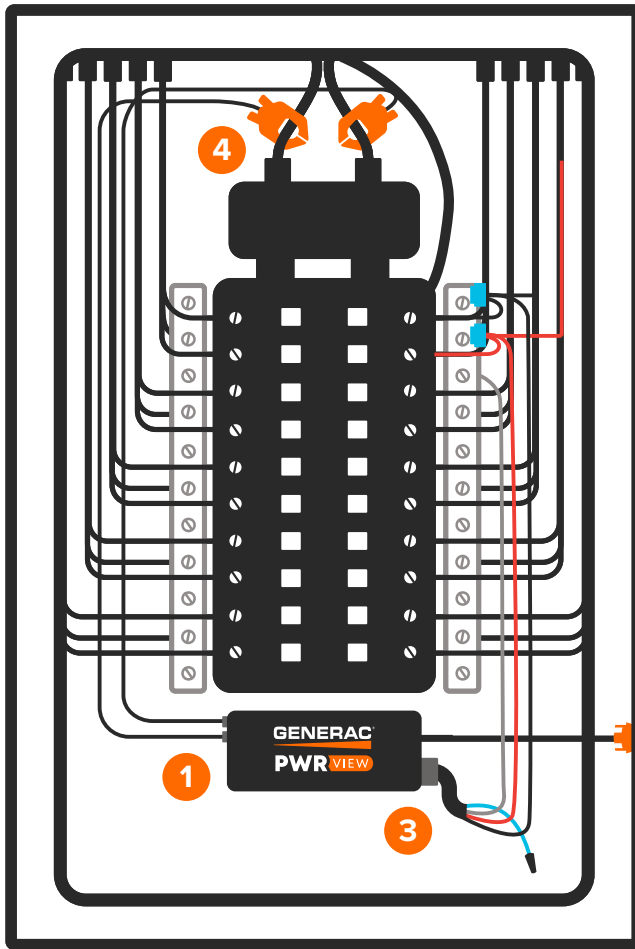

**NOTE:** You can use the 2 cable ties to clean up your PWRview's wiring.

# Step 8

## CONNECT TO THE PWRVIEW INSTALLER APP

Now that the PWRview Meter has been installed, use the PWRview Installer App to complete the installation.





# Step 9

## PUT ON PANEL COVER



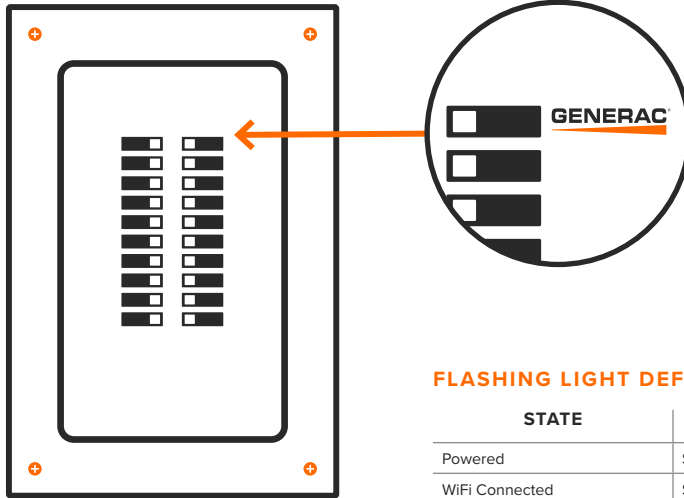

You're almost done. Screw the cover back onto your panel. Make sure to place the supplied Generac breaker label next to the breaker with PWRview's black wire:



## FLASHING LIGHT DEFINITIONS

STATE	LED BEHAVIOUR
Powered	Solid Red
WiFi Connected	Solid Blue
Normal Operation	"Breathing" Blue
WiFi Network Lost	Slow Flashing Blue (2s/2s)
Attempting to Join WiFi Network	Fast Flashing Blue (0.5s/0.5s)
Configuration Data Transfer	Blinking Purple
Firmware Upgrade in Progress	Solid Yellow

When powered on, PWRview will play the following tones to indicate its status in sequential order:

TONE	INDICATION	DESCRIPTION
Short beeps 	Voltage check	One beep for each voltage wire that is connected. For a 2-phase installation there should be two beeps to indicate that the black and red wires are connected.
Short chime 	PWRview's WiFi network started	PWRview has started hosting its own WiFi network. You can join this network to configure PWRview and connect it to your own WiFi network.
Long beep 	Voltage warning (conditional)	Indicates that two wires are connected to the same phase. For North American apartments, this means that one of PWRview's wires should be moved to a different breaker. This tone can be ignored for all other 2-phase installations.
Long chime 	PWRview joined network successfully	PWRview successfully joined your WiFi network
Falling tone 	PWRview failed to join network	PWRview was unable to join your WiFi network. PWRview will now start hosting its own WiFi network again to allow you to re-connect to PWRview and re-enter the WiFi credentials

## FCC PART 15

This device complies with FCC Rules Part 15 operation is subject to the following two conditions:

This device may not cause harmful interference.

This device must accept any interference, including interference that may cause undesired operation of the device.

Changes or modifications to this device, not expressly approved by Generac Power Systems, Inc. could void the user's authority to operate the equipment.

Contains FCCID: W72-N1LD

Contains IC: 8253A-N1LD

## INDUSTRY CANADA NOTIFICATIONS

This device complies with Industry Canada's license-exempt RSSs. Operation is subject to the following two conditions:

1. This device may not cause interference; and
2. This device must accept any interference, including interference that may cause undesired operation of the device.

Le présent appareil est conforme aux CNR d'Industrie Canada applicables aux appareils radio exempts de licence. L'exploitation est autorisée aux deux conditions suivantes:

1. l'appareil ne doit pas produire de brouillage;
2. l'utilisateur de l'appareil doit accepter tout brouillage radioélectrique subi, même si le brouillage est susceptible d'en compromettre le fonctionnement

## FCC RF EXPOSURE REQUIREMENTS

This product complies with the FCC RF exposure limit set forth for an uncontrolled environment and is safe for intended operation as described in this manual. This device is only authorized for use in a mobile application, at least 20cm of separation distance between the radiating antenna and the user's body must be maintained at all times. Further RF exposure reduction can be achieved if the product can be kept as far as possible from the user's body or set the device to a

lower output power if such a function is available. Separate approval is required for all other operating configurations, including portable configurations with respect to 47 CFR Part 2.1093 and different antenna configurations.

**⚠ WARNING** Installing PWRview requires working with voltages that may cause serious bodily injury or even death, and this should only be done by a qualified professional. Installations should be performed in accordance with the applicable electrical code for the region in which PWRview is being installed. Whenever possible, power should be disconnected upstream from the installation location before attempting installation of PWRview. If power cannot be disconnected, high voltages may still be present, and warning must be taken to avoid injury. If PWRview is not used as instructed, its protection mechanisms may be impaired.

### RULES:

1. Installations should be performed by a qualified professional and in accordance with the applicable electrical code for the region in which PWRview is being installed.
2. Do not use PWRview with voltages that exceed 240V.
3. Only install PWRview in approved breaker panels or enclosures.
4. PWRview must not be exposed to moisture, direct sunlight, extremely low or high temperatures, and conductive pollution. Consult the User Manual for PWRview's acceptable operating environment.
5. PWRview must be installed in a location that limits access to only qualified personnel.



WARRANTY INFORMATION CAN BE FOUND AT:  
[WWW.GENERAC.COM/SERVICE-SUPPORT/PWRVIEW](http://WWW.GENERAC.COM/SERVICE-SUPPORT/PWRVIEW)

PMN: PWRview Communications Module

## QUESTIONS OR FEEDBACK?

[WWW.GENERAC.COM/SERVICE-SUPPORT/CONTACT-US](http://WWW.GENERAC.COM/SERVICE-SUPPORT/CONTACT-US)