



4500 Watt Generator Owner's Manual



Model No. TPP-4500DF-A For Service Please Call Toll free: 1-866-591-8921

⚠ WARNING ⚠

Read and follow all safety rules and instructions in this manual before attempting to operate this machine. Failure to comply with these instructions may result in personal injury.

Diagrams within this manual may not be drawn proportionally. Due to continuing improvements, actual product may differ slightly from the product described herein.



WARNING:



The engine exhaust from this product contains chemicals known to the State of California to cause cancer, birth defects or other reproductive harm.

TABLE OF CONTENTS

SAFETY GUIDELINES3

GENERATOR COMPONENTS 13

WATTAGE REFERENCE CHART..... 16

PRE-OPERATION CHECK..... 17

STARTING THE GENERATOR..... 19

STOPPING THE GENERATOR..... 20

OPERATION INSTRUCTIONS 20

MAINTENANCE 22

STORAGE 26

INSTALLATION..... 26

TROUBLESHOOTING 28

WIRING DIAGRAM..... 29





MODEL SPECIFICATIONS..... 30

Safety Guidelines



This manual contains important information that you need to know and understand in order to protect YOUR SAFETY and to PREVENT EQUIPMENT PROBLEMS. The following symbols help you recognize this information. These labels warn you of potential hazards that can cause serious injury. Read them carefully.

Please read the manual and pay attention to these sections.



Save These Important Safety Instructions!

	Read and understand all of these safety instructions. Be sure to retain them for future use.
	WARNING! Warnings indicate a certainty or strong possibility of personal injury or death if instructions are not followed.
	CAUTION: Cautions indicate a possibility of personal injury or equipment damage if instructions are not followed.
	NOTE: Notes give helpful information.

General Precautions

	<p>WARNING! FAILURE TO FOLLOW THESE INSTRUCTIONS CAN RESULT IN SEVERE INJURY OR DEATH.</p>
	<p>CAUTION: FAILURE TO FOLLOW THESE INSTRUCTIONS CAN ALSO RESULT IN DAMAGE TO THE TOOL AND/OR THE ITEM YOU ARE WORKING ON</p>
	<p>WARNING! IMPROPER OPERATION OR MAINTENANCE OF THIS PRODUCT COULD RESULT IN SERIOUS INJURY AND PROPERTY DAMAGE. READ AND UNDERSTAND ALL WARNINGS AND OPERATING INSTRUCTIONS BEFORE USING THIS EQUIPMENT. WHEN USING AIR TOOLS, BASIC SAFETY PRECAUTIONS SHOULD ALWAYS BE FOLLOWED TO REDUCE THE RISK OF PERSONAL INJURY.</p>

Specific Warnings

<h2>Carbon Monoxide</h2>	
	<p>When this tool is running, ensure that the area is well ventilated. Never run the engine in an enclosed area. Run the engine in an open area or with an exhaust evacuation system in an enclosed area.</p>
	<p>WARNING! THE EXHAUST CONTAINS POISONOUS CARBON MONOXIDE GAS THAT CAN BUILD UP TO DANGEROUS LEVELS IN CLOSED AREAS. BREATHING CARBON MONOXIDE CAN CAUSE UNCONSCIOUSNESS OR DEATH.</p> <ul style="list-style-type: none"> • Never run the generator in a closed or even partly closed area where people may be present.

Gasoline and Oil



This product requires oil and fuel. Attempting to start the engine without oil will ruin the engine and void the warranty. Work in a well-ventilated area. Keep cigarettes, flames or sparks away from the work area or where gasoline is stored.



GASOLINE IS HIGHLY FLAMMABLE AND EXPLOSIVE. YOU COULD BE BURNED OR SERIOUSLY INJURED IF THE GASOLINE IS IGNITED.

- Before refueling, stop the engine and keep heat, sparks and flame away.
- Handle fuel only outdoors.
- Do not fill the fuel tank above the upper limit line.
- Wipe up fuel and oil spills immediately.
- Gasoline and its fumes are flammable and potentially explosive. Use proper fuel storage and handling procedures. ALWAYS HAVE MULTIPLE ABC CLASS FIRE EXTINGUISHERS HANDY.
- KEEP THE GENERATOR AND SURROUNDING AREA CLEAN AT ALL TIMES. Dispose of fluids and cleaning materials as per any local, state, or federal codes and regulations. Store oily rags in a covered metal container.
- NEVER STORE FUEL OR OTHER FLAMMABLE MATERIALS NEAR THE GENERATOR.
- Do not smoke or allow sparks, flames or other sources of ignition around the engine and fuel tank. Fuel vapors are explosive.
- Keep grounded conductive objects, such as tools, away from exposed, live electrical parts and connections to avoid sparking or arcing. These events could ignite fumes or vapors.
- Do not refill the fuel tank while the engine is running or while the engine is still hot. Do not operate the generator with known leaks in the fuel system.
- Excessive buildup of unburned fuel or gases in the exhaust system can create a potentially explosive condition. This buildup can occur after repeated failed start attempts, valve testing, or hot engine shutdown. If this occurs, open exhaust system drain plugs, if equipped, and allow the gases to dissipate before attempting to restart the generator.
- Only use engine oil and fuel recommended by manufacturer.

Hot Components



WARNING! ENGINE AND EXHAUST SYSTEM PARTS BECOME VERY HOT AND REMAIN HOT FOR SOME TIME AFTER THE ENGINE HAS STOPPED. WEAR INSULATED GLOVES OR WAIT UNTIL THE ENGINE AND EXHAUST SYSTEM HAVE COOLED BEFORE HANDLING THE PARTS.

Electrical Safety



Grounded tools must be plugged into an outlet properly installed and grounded in accordance with all codes and ordinances. Never remove the grounding prong or modify the plug in any way. Do not use any adapter plugs.



Grounding provides a low-resistance path to carry electricity away from the user in the event of an electrical malfunction.



Double insulated tools are equipped with a polarized plug, where one blade is wider than the other. This plug fits in a polarized outlet only one way. If the plug does not fit fully in the outlet, reverse the plug. If it still does not fit, contact a qualified electrician to install a polarized outlet. Do not change the plug in any way. Double insulation eliminates the need for the three-wire grounded power cord and grounded power supply system.

Avoid body contact with grounded surfaces such as pipes, radiators, ranges, and refrigerators. There is an increased risk of electric shock if your body is grounded.

Do not abuse the power cord for your tools or equipment. Keep power cords away from heat, oil, sharp edges, or moving parts. Replace damaged power cords immediately. Damaged power cords increase the risk of electric shock.

When operating a power tool outside, use an outdoor extension cord marked “W-A” or “W”. These extension cords are rated for outdoor use, and reduce the risk of electric shock.

Connect the generator only to a load or electrical system (120 volt) that is compatible with the electrical characteristics and rated capacities of the generator.

Before servicing equipment powered by the generator, disconnect the equipment from its power input.

Insulate all connections and disconnected wires.

Guard against electric shock. Prevent body contact with grounded surfaces such as pipes, radiators, ranges, and refrigerator enclosures.





IMPROPER CONNECTIONS TO A BUILDING CAN ALLOW ELECTRICAL CURRENT TO BACK FEED INTO UTILITY LINES, CREATING AN ELECTROCUTION HAZARD.

- CONNECTIONS TO A BUILDING MUST ISOLATE THE GENERATOR POWER FROM UTILITY POWER AND COMPLY WITH ALL APPLICABLE LAWS AND ELECTRICAL CODES.
- All connections and conduits from the generator to the load must only be installed by trained and licensed electricians, and in compliance with all relevant local, state, and federal electrical codes and standards, and other regulations where applicable.
- The generator must be earth-grounded for fixed installations in accordance

	with all relevant electrical codes and standards before operation.
	<p>THE GENERATOR IS A POTENTIAL SOURCE OF ELECTRICAL SHOCK IF NOT KEPT DRY.</p> <ul style="list-style-type: none"> • DO NOT EXPOSE THE GENERATOR TO MOISTURE, RAIN OR SNOW. Water entering a generator will increase the risk of electric shock. • DO NOT OPERATE THE GENERATOR WITH WET HANDS. • Do not attempt to connect or disconnect load connections while standing in water, or on wet or soggy ground. • Do not touch electrically energized parts of the generator and interconnecting cables or conductors with any part of the body, or with any non-insulated conductive object. • Keep all electrical equipment clean and dry. Replace any wiring where the insulation is cracked, cut abraded or otherwise degraded. Replace terminals that are worn, discolored, or corroded. Keep terminals clean and tight.

Power Output

 	<p>This generator is not designed to power sensitive electronic equipment (such as computers, mobile phones, medical devices and the like) without the addition of an approved line conditioner, which is sold separately.</p> <p>ATTEMPTING TO POWER SENSITIVE ELECTRONIC EQUIPMENT WITHOUT THE USE OF AN APPROVED LINE CONDITIONER MAY CAUSE DAMAGE TO THE EQUIPMENT. NEITHER TILLOTSON POWER PRODUCTS LLC NOR ANY OF ITS AFFILIATES ARE RESPONSIBLE FOR ANY DIRECT OR INDIRECT DAMAGE CAUSED BY FAILURE TO USE AN APPROVED LINE CONDITIONER.</p>
---	--

Work Area

	<p>Keep your work area clean and well lit. Cluttered benches and dark areas invite accidents.</p> <p>Do not operate power tools in explosive atmospheres, such as in the presence of flammable liquids, gases, or dust. Generators create sparks which may ignite the dust or fumes.</p> <p>Keep bystanders, children and visitors away while operating a generator. Provide barriers or shields as needs.</p>
---	--

Personal Safety



Stay alert. Watch what you are doing, and use common sense when operating a generator. Do not use generator while tired or under the influence of drugs, alcohol, or medication. A moment of inattention while operating generators may result in serious personal injury.



Dress properly. Do not wear loose clothing or jewelry. Contain long hair. Keep your hair, clothing, and gloves away from moving parts. Loose clothes, jewelry, or long hair can be caught in moving parts.



Avoid accidental starting. Make sure the power switch is in its “OFF” position and disconnect the spark plug wire when not in use.

Remove adjusting keys or wrenches before turning the generator on. A wrench or a key that is left attached to a rotating part of the generator may result in personal injury.

Do not overreach. Keep proper footing and balance at all times.

Use safety equipment. Always wear eye protection. Wear ANSI approved safety impact eye goggles. Dust mask, non-skid safety shoes, hardhat, or hearing protection must be used for appropriate conditions.

Do not force the generator. Use the correct generator for your application. The correct generator will do the job better and safer at the rate for which it is designed.

Do not use the generator if the power switch does not turn it off. Any generator that cannot be controlled with the power switch is dangerous and must be replaced.

Generator Use and Care



Make sure the power switch is in its “OFF” position and disconnect the spark plug wire before making any adjustment, changing accessories, or storing the generator. Such preventative safety measures reduce the risk of starting the generator accidentally.



Store idle generators out of reach of children and other untrained persons. Generators are dangerous in the hands of untrained users.





Maintain generators with care. Do not use a damaged generator. Tag damaged generators “Do not use” until repaired.

Check for misalignment or binding of moving parts, broken parts, and any other condition that may affect the generator’s operation. If damaged, have the generator serviced before using. Many accidents are caused by poorly maintained generators.

	Use only accessories that are recommended by the manufacturer for your model. Accessories that may be suitable for one generator may become hazardous when used on another generator.
--	---



Servicing



	Maintain labels and nameplates on the generator and engine. These carry important information. If unreadable or missing, contact the service number on the front page of this manual or Tillotson Power Products LLC immediately for a replacement.
	 <p>Generator service must be performed only by qualified repair personnel. Service or maintenance performed by unqualified personnel could result in a risk of injury.</p> <p>When servicing a generator, use only identical replacement parts. Follow all appropriate instructions in this manual. Use of unauthorized parts or failure to follow maintenance instructions may create a risk of electric shock or injury.</p>

Heart Pacemakers



	WARNING! PEOPLE WITH PACEMAKERS SHOULD CONSULT THEIR PHYSICIAN(S) BEFORE USING THIS PRODUCT. ELECTROMAGNETIC FIELDS IN CLOSE PROXIMITY TO A HEART PACEMAKER COULD CAUSE INTERFERENCE TO OR FAILURE OF THE PACEMAKER.
--	---



Installation

	Ensure installation meets all applicable safety, local and national electrical codes. Have installation performed by a qualified, licensed electrician and building contractor.
	 <p>All electrical work, including the earth-ground connection, should be completed by a licensed electrician.</p> <p>Any separate fuel storage or generator supply facility must be built or installed in full compliance with all relevant local, state, and federal regulations.</p>
	 <p>It is recommended to use the generator only in well-ventilated, outdoor areas. A running gasoline engine will generate carbon monoxide, a colorless, odorless gas that, if inhaled, can cause serious injury or death. If the generator is installed indoors, exhaust fumes must be piped out of the building using leak-free, heat resistant piping. Pipes and silencer should not use any flammable materials, nor should they be installed near the same. Generator exhaust fumes must be within legal limits and installation must always meet local building codes.</p>

  	<p>If the generator is installed outdoors, it must be weatherproofed and should be soundproofed. It should not be run outdoors without protection to the generator and wiring conduit.</p> <p>Before lifting the generator, ensure the lift rigging and supporting structure are in good condition, and are rated to lift such a load.</p> <p>Keep all personnel away from the suspended generator during relocating.</p> <p>The supporting floor/ground surface should be level and strong enough to safely hold the weight of the generator. If the floor/grounded surface is not level, strong cross members should be placed under the full length of the generator frame at its low side.</p> <p>For trailer installation, the generator should be mounted on the center point of the trailer, over the wheels. The trailer must be capable of supporting the weight of the generator and all contents (tools, etc.).</p> <p>Install sound-and weatherproofing only when it is not raining or snowing to avoid trapping moisture within the generator’s area.</p>
---	--

Mechanical

 	<p>Always make sure the power switch is in its “OFF” position. Disconnect the spark plug wire, and allow the engine to completely cool before carrying out maintenance.</p> <p>Check for damaged parts. Before using the generator, any part that appears damaged should be carefully checked to determine that it will operate properly and perform its intended function. Check for alignment and binding of moving parts, any broken parts or mounting fixtures, and any other condition that may affect proper operation.</p> <p>The generator is designed with guards for protection from moving parts. Care must still be taken to protect personnel and equipment from other mechanical hazards when working around the generator.</p> <p>Do not operate the generator with safety guards removed. While the generator is running, do not attempt to reach around the safety guard for maintenance or any other reason.</p> <p>Keep hands, arms, long hair, loose clothing, and jewelry away from moving parts. Be aware that when engine parts are moving fast they cannot be seen clearly.</p> <p>Keep access doors on enclosures closed and locked when access is not required.</p>
--	---

	<p>When working on or around the generator, always wear protective clothing, including ANSI approved safety gloves, safety eye goggles, and safety hat.</p> <p>Do not alter or adjust any part of the generator that is assembled and supplied by the manufacturer.</p> <p>Always follow and complete scheduled engine and generator maintenance.</p>
Chemicals	
	<p>Avoid contact with hot fuel, oil, exhaust fumes, and hot solid surfaces.</p> <p>Avoid body contact with fuels, oils, and lubricants used in the generator. If swallowed, seek medical treatment immediately. Do not induce vomiting if fuel is swallowed. For skin contact, immediately wash with soap and water. For eye contact, immediately flush eyes with clean water and seek medical attention.</p>
Noise	
	<p>Prolonged exposure to noise levels above 68 DBA is hazardous to hearing. Always wear ANSI approved ear protection when operating or working around the generator when it is running.</p>

Additional Safety Information

Operator Responsibility

- Know how to stop the generator quickly in case of emergency. See page 20.
- Understand the use of all generator controls, output receptacles and connections.
- Do not let children operate the generator without parental supervision.

Electric Shock Hazards

- The generator produces enough electric power to cause a serious shock or electrocution if misused.
- Using a generator or electrical appliance in wet conditions, such as rain or snow, or near a pool or sprinkler system, or when your hands are wet, could result in electrocution. Keep the generator dry.
- If the generator is stored outdoors, unprotected from the weather, check all of the electrical components on the control panel before each use.
- Moisture or ice can cause a malfunction or short circuit in electrical components, which could result in electrocution.
- Do not connect to a building electrical system unless a qualified electrician has installed an isolation switch.

Fire and Burn Hazards

- The exhaust system gets hot enough to ignite some materials.
 - Keep the generator at least 3 feet (1 meter) away from buildings and other equipment during operation.
 - Do not enclose the generator in any structure. Keep flammable materials away from the generator.
- The muffler becomes very hot during operation and remains hot for a while after stopping the engine. Be careful not to touch the muffler while it is hot. Let the engine cool before storing the generator indoors.
- Gasoline is extremely flammable and is explosive under certain conditions. Do not smoke or allow flames or sparks where the generator is refueled or where gasoline is stored. Refuel in a well-ventilated area with the engine stopped.
- Fuel vapors are extremely flammable and may ignite after the engine has started. Make sure that any spilled fuel has been wiped up before starting the generator.

GENERATOR COMPONENTS

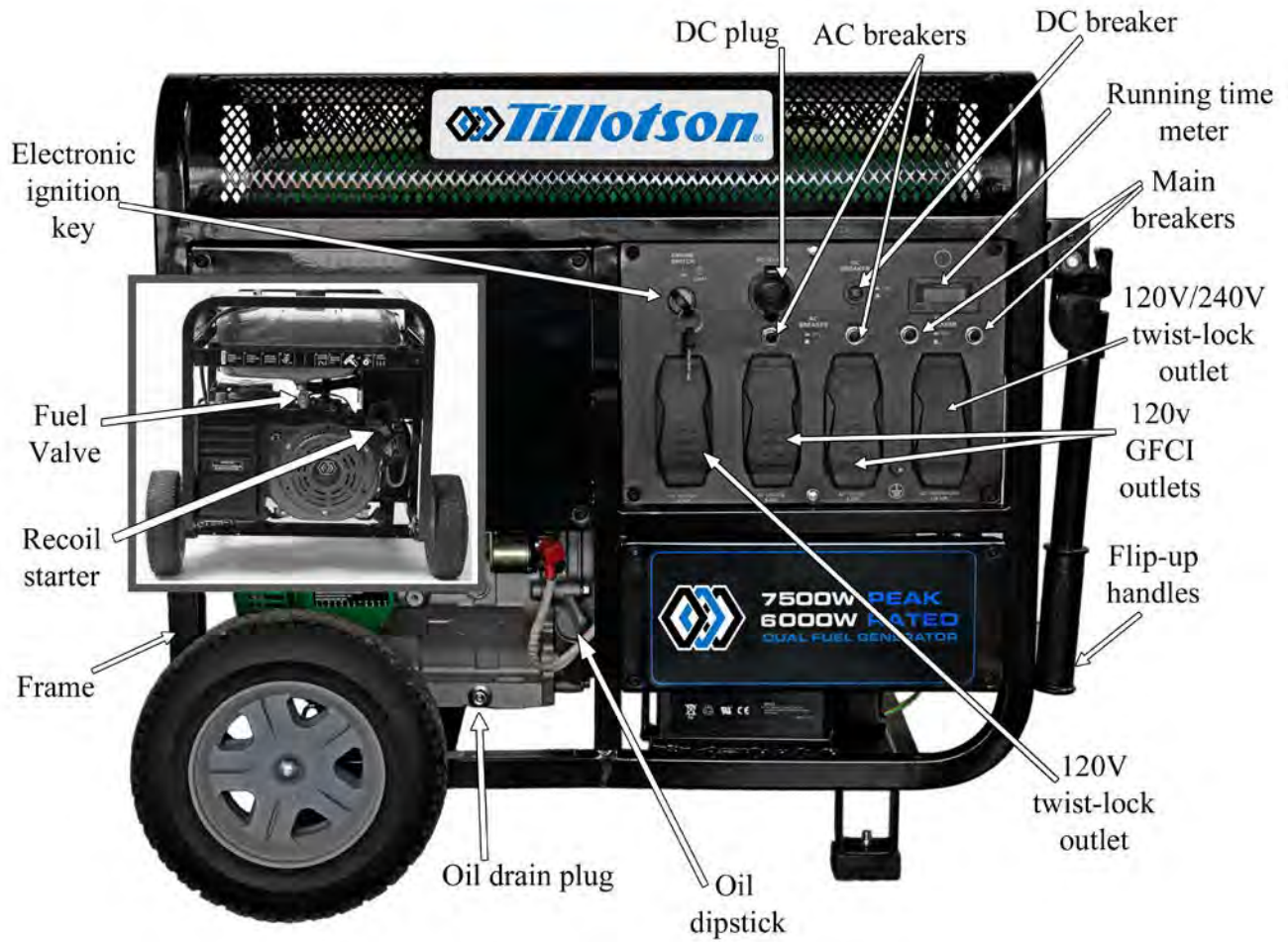

See next page for further explanations.

Engine Key Positions:

Off: Key should be in the OFF position when generator is not in use. Key may also be turned to the off position to stop the engine.

ON: Key should be in the ON positions while engine is running or prior to starting the engine with the remote or recoil starter.

START: Turn key to start position to start the engine.

	<p>Do not turn the key switch to START position when the engine is running. Doing so may damage the starting motor.</p> <p>Do not leave key in the ignition unattended.</p>
---	---

For starting instructions, see STARTING THE GENERATOR on page 19.

Recoil Starter:

The recoil starter may be used to start the engine instead of the key or if the battery is discharged. To start the engine, pull the starter grip lightly until resistance is felt, then pull briskly. Repeat as necessary to start. See STARTING THE GENERATOR on page 16 for more information.

	<p>Do not allow the recoil starter handle to snap back against the engine. Return it gently to prevent damage to the starter.</p> <p>When starting the engine by recoil starter, set the key switch to the ON position and pull the recoil starter handle.</p>
--	--

Gasoline Fuel Valve:

The gasoline fuel valve is located between the fuel tank and carburetor. When the lever is in the off (horizontal) position, the valve is closed and gasoline will not flow from the gas tank to the engine.

When the valve lever is turned to the ON (vertical) position, gasoline is allowed to flow from the fuel tank to the carburetor.

Be sure to return the fuel valve lever to the OFF position after stopping the engine.

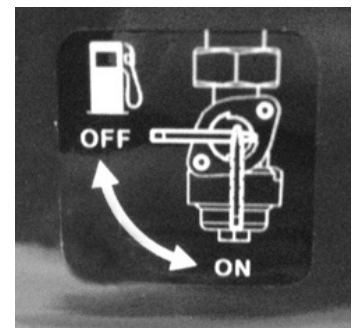

Choke Lever:

The choke is used to help start a cold engine. The choke shutter reduces the amount of air being mixed with fuel, thus providing an enriched fuel mixture which combusts more easily. To close (engage) the choke for starting, slide the choke lever to the left (toward the rear of the generator). Once the engine has started and is running steadily, the choke should be opened (disengaged) by turning the lever to the right to the open position.



Ground Terminal:

The generator ground terminal is connected to the frame of the generator, the metal non-current-carrying parts of the generator and the ground terminals of each receptacle.

DC Circuit Breaker:

The DC circuit breaker automatically shuts off the DC battery charging circuit when the DC charging circuit is overloaded, when there is a problem with the battery or when the connections between the battery and the generator are improper.

Oil Alert System:

The Oil Alert system is designed to prevent engine damage caused by an insufficient amount of oil in the crankcase. Before the oil level in the crankcase can fall below a safe limit, the Oil Alert system will automatically stop the engine (the engine switch will remain in the ON position). The Oil Alert system should not take the place of checking the oil level before each use. If the engine stops and will not restart, check the engine oil level before troubleshooting in other areas.

AC Circuit Breaker:

The AC circuit breaker will automatically switch OFF if there is a short circuit or a significant overload of the generator at the receptacle. If the AC circuit breaker is switched OFF automatically, check that the appliance is working properly and does not exceed the rated load capacity of the circuit before switching the AC circuit breaker ON again. The AC circuit breaker may be used to switch the generator power ON or OFF.

WATTAGE REFERENCE CHART

Electric equipment, especially engines, produce strong current when being started. The table below offers references when you connect those installations to generator.

Tool or Appliance	Rated* (Running) Watts	Additional Surge (Starting) Watts
<u>Essentials</u>		
Light Bulb – 75 watt	75	–
Deep Freezer	500	500
Sump Pump	800	1200
Refrigerator/Freezer – 18 cu. ft.	800	1600
Water Well Pump – 1/3 HP	1000	2000
<u>Heating/Cooling</u>		
Window Air Conditioner – 10000 BTU	1200	1800
Window Fan	300	600
Furnace Fan Blower – 1/2 HP	800	1300
<u>Kitchen</u>		
Microwave Oven – 1000 watt	1000	–
Coffee Maker	1500	–
Electric Stove – Single Element	1500	–
Hot Plate	2500	–
<u>Family Room</u>		
DVD/CD Player	100	–
VCR	100	–
Stereo Receiver	450	–
Color Television- 27”	500	–
Personal Computer w/17” Monitor	800	–
<u>Other</u>		
Security System	180	–
AM/FM Clock Radio	300	–
Garage Door Opener- 1/2 HP	480	520
Electric Water Heater – 40 Gallon	4000	–
<u>DIY / Job Site</u>		
Quartz Halogen Work Light	1000	–
Airless Sprayer – 1/3 HP	600	1200
Reciprocating Saw	960	960
Electric Drill- 1/2 HP	1000	1000
Circular Saw – 7 1/4”	1500	1500
Miter Saw – 10”	1800	1800
Table Planer- 6”	1800	1800
Table Saw / Radial Arm Saw – 10”	2000	2000
Air Compressor – 1 1/2 HP	2500	2500

*Wattages listed are approximate only. Check tool or appliance for actual wattage.

PRE-OPERATION CHECKLIST

1. Connect the Battery

- Connect the positive wire to the positive terminal of the battery and the negative wire to the negative terminal of the battery.

2. Fill or Check the Engine Oil

- **CAUTION: PRIOR TO FIRST USING THE GENERATOR, THE ENGINE MUST BE FILLED WITH A HIGH QUALITY SAE 10W-30 OR OTHER SUITABLE GRADE ENGINE OIL.** To do so, unscrew and remove the engine's oil dipstick located at the bottom of the engine crankcase. Fill the engine's crankcase with the included oil until the oil level is level with the upper marked line on the dipstick, and then screw the dipstick back into the oil fill hole. **FILL OIL ON A LEVEL SURFACE.**
- **Check the oil level BEFORE EACH USE with the generator on a level surface and the engine stopped.**
 - Remove the oil filler cap and wipe the dipstick clean.
 - Check the oil level by inserting the dipstick into the filler neck without screwing it in.
 - If the level is low, fill to the top of the oil filler neck with the recommended oil (see below). Use the enclosed funnel to avoid spilling oil.

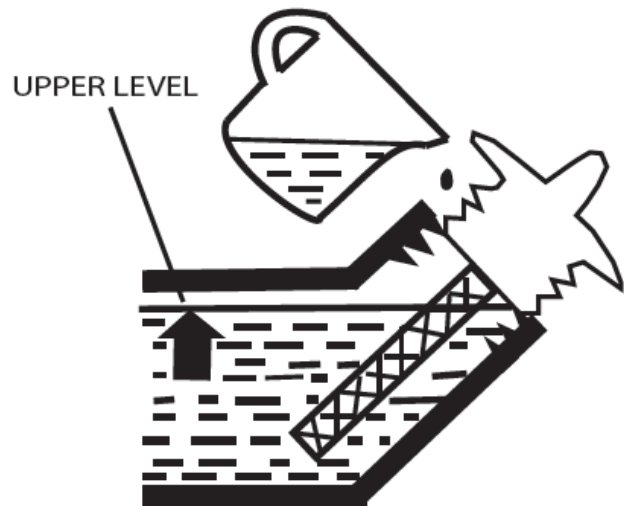
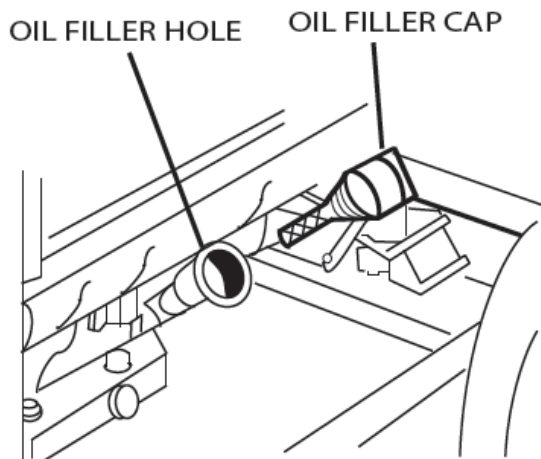

- **Use only 4-stroke motor oil** that meets or exceeds the requirements for API service classification SJ. **SAE 10W-30** is recommended for general, all-temperature use. Other viscosities shown in the chart may be used when the average temperature in your area is within the indicated range.

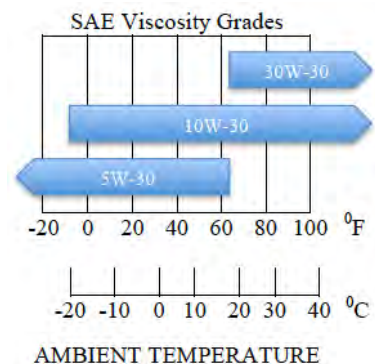



	<p>Engine oil is a major factor affecting engine performance and service life. Non-detergent and 2-stroke engine oils will damage the engine and are not recommended. Always check the API SERVICE label on the oil container to be sure it includes the letter SJ.</p>
---	---

3. Fuel

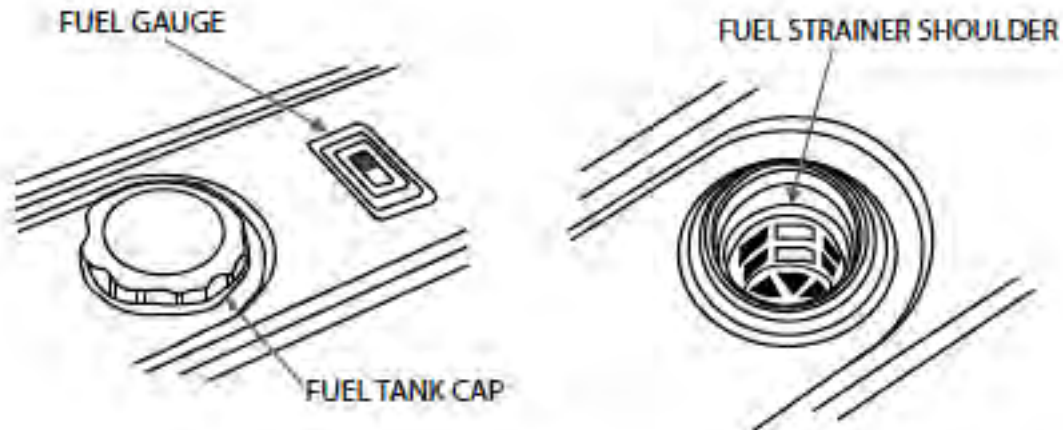
- **Check** the fuel gauge and refill the tank if the fuel level is low. Do not use gasoline with more than 10% ethanol.
- **Refuel** carefully to avoid spilling fuel. Do not fill above the shoulder of the fuel strainer.



 	<p>Gasoline is highly flammable and explosive and you can be burned or seriously injured when refueling.</p> <ul style="list-style-type: none"> ◆ Stop engine and keep heat, sparks and flame away from the gasoline and engine. ◆ Refuel only outdoors. ◆ Wipe up spills immediately. ◆ Use unleaded gasoline with a pump octane rating of 86 or higher. ◆ This engine is certified to operate on unleaded gasoline. Unleaded gasoline produces fewer engine and spark plug deposits and extends exhaust system life. Never use stale or contaminated gasoline or an oil/gasoline mixture. Avoid getting dirt or water in the fuel tank.
--	--

4. LPG Operation

- When using LPG instead of gasoline, make sure that there is no gasoline in the engine by closing the fuel valve and running the engine until it stops.
- Locate the LPG converter on the backside of the generator.
- Attach the small end of the gas hose to the LPG converter.
- Connect the gas hose to the propane fuel source.
- Turn the LPG valve on the LPG tank to the ON position. **Do not turn on the propane source prior to following the steps outlined above.**
- See next section for starting the engine.

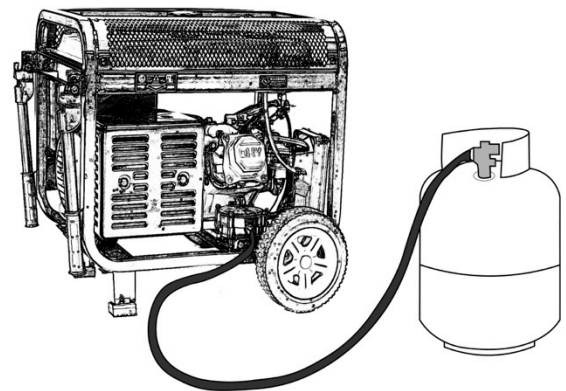

STARTING THE GENERATOR

Gasoline

- Make sure that the AC circuit breaker is in the OFF position. The generator may be hard to start if a load is connected.
- Turn the fuel valve lever to the ON (vertical) position.
- Check to make sure the choke is closed if the engine is cold. Turn the choke level to the left.
- Insert key and turn the engine switch to the ON position.

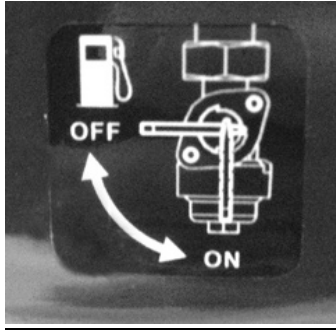

- You can start then engine using any of the following methods.
 - **Ignition key.** Turn the ignition switch to the ON position and hold for a few seconds. **DO NOT HOLD FOR MORE THAN 5 SECONDS.** If the engine fails to start, release the switch and wait 10 seconds before operating the starter again.

	<p>NOTE: If the speed of the starter motor drops after a period of time, it is an indication that the battery should be recharged. When the engine starts, release the key to allow the engine switch to return to the ON position.</p>
	<p>Operating the starter motor for more than 5 seconds can damage the motor.</p>

- **Recoil start.** Pull the starter grip lightly until resistance is felt, then pull briskly. Do not let the handle snap back. Rather, guide the handle gently back to the engine.
- Once the engine has started and warms up, disengage the choke by pushing the choke lever to the OPEN position.

LPG

- Drain the fuel system completely of gasoline. You can do this by starting the engine with gasoline, closing the gasoline valve and running the engine until dry.
- Once dry, push the LPG converter button 2 times.
- Close the choke.
- Turn the ignition key to the ON position.
- For electronic start, turn the ignition key further to the start position.
- For recoil start, pull the recoil handle briskly. Do not let the handle snap back. Rather, guide the handle gently back to the engine.
- Once the engine has started and warms up, open the choke.

STOPPING THE GENERATOR

In an emergency:

- To stop the engine in an emergency, move the engine switch to the OFF position.

In normal use:

- Turn the AC circuit breaker to the OFF position. Disconnect DC battery charging cables.
- Press the Off button on the remote control for few seconds or turn the engine switch to the OFF position.
- Turn the fuel valve lever to the OFF position.
-

OPERATING INSTRUCTIONS

Connections to a Building Electrical System

Connections for standby power to a building electrical system must be made by a qualified electrician. The connection must isolate the generator power from utility power and must comply with all applicable laws and electrical codes. A transfer switch, which isolates generator power from utility power, is a prerequisite to a safe installation.

	<p>Improper connections to a building electrical system can allow electrical current from the generator to back feed into the utility lines. Such back feed may electrocute utility company workers or others who contact the lines during a power outage, and the generator may explode, burn or cause fires when utility power is restored. Consult the utility company or a qualified electrician.</p>
---	---



Ground System

The portable generators have a system ground that connects generator frame components to the ground terminals in the AC output receptacles. The system ground is not connected to the AC neutral wire.

AC Applications

Before connecting an appliance or power cord to the generator:

- Make sure that it is in good working order. Faulty appliances or power cords can create a potential for electrical shock.
- If an appliance begins to operate abnormally, becomes sluggish or stops suddenly, turn it off immediately. Disconnect the appliance and determine whether the problem is the appliance or if the rated load capacity of the generator has been exceeded.
- Prior to powering tools and equipment, make sure the generator's rated voltage, and amperage capacity (120VAC @ 27 AMPs) is adequate to supply all electrical loads that the unit will power. If powering exceeds the generator's capacity, it may be necessary to group one or more of the tools and/or equipment for connection to a separate generator. Power levels between rated and maximum may be used for no more than 30 minutes.

	<p>CAUTION: ATTEMPTING TO POWER SENSITIVE ELECTRONIC EQUIPMENT SUCH AS COMPUTERS AND MEDICAL DEVICES WITHOUT THE USE OF AN APPROVED LINE CONDITIONER MAY CAUSE DAMAGE TO THE EQUIPMENT. NEITHER TILLOTSON POWER PRODUCTS LLC NOR ITS AFFILIATES ARE RESPONSIBLE FOR ANY DIRECT OR INDIRECT DAMAGE CAUSED BY THE FAILURE TO USE AN APPROVED LINE CONDITIONER.</p>
	<p>CAUTION: Substantial overloading will open the circuit breaker. Exceeding the time limit for maximum power operation or slightly overloading the generator may not switch the circuit breaker or circuit protector OFF, but will shorten the service life of the generator.</p>

AC Operation

- Start the engine.
- Switch the AC circuit breaker ON.
- Plug in the appliance.

Most motorized appliances require more than their rated power for startup. Do not exceed the current limit specified for any one receptacle.

	<p>NOTE: The generator features an AC non-fuse circuit breaker to protect the ac circuit in case of an overload. Should an overload occur, the breaker will “trip” to its “off” position, causing the generator to automatically shut down. In this case wait a few minutes and then, reset the circuitry system by turning the circuit breaker to its “on” position. Restart the generator and continue powering the remaining tools and equipment.</p>
---	---

High Altitude Operation

At high altitude, the standard carburetor air/fuel mixture may be too rich due to the lower air density. In that case, performance will decrease and fuel consumption will increase. A very rich mixture will

also foul the spark plug and make it difficult to start the engine. Operation at an altitude that differs from that at which this engine was certified for extended periods of time may increase emissions. High altitude performance can be improved by specific modifications to the carburetor. If you always operate your generator at altitudes above 5,000 feet (1,500 meters), have your dealer perform this carburetor modification. This engine, when operated at high altitude with the carburetor modifications for high altitude use, will meet each emission standard throughout its useful life. Even with carburetor modification, engine horsepower may decrease about 3.5% for each 1,000-foot (300-meter) increase in altitude. The effect of altitude on horsepower will be greater than this if no carburetor modification is made.

	When the carburetor has been modified for high altitude operation, the air/fuel mixture will be too lean for low altitude use. Operation at altitudes below 5,000 feet (1,500 meters) with a modified carburetor may cause the engine to overheat and result in serious engine damage.
---	--

MAINTENANCE

Good maintenance is essential for safe, economical and trouble-free operation. It will also help reduce air pollution.

	Improper maintenance or failure to correct a problem before operation can cause a malfunction in which you can be seriously injured or killed. Always follow the inspection and maintenance recommendations and schedules in this instruction manual.
--	---

Maintenance Safety

- Make sure the engine is off before you begin any maintenance or repairs.
- Let the engine and exhaust system cool before touching.
- To reduce the possibility of fire or explosion, be careful when working around gasoline. Use only a nonflammable solvent, not gasoline, to clean parts. Keep cigarettes, sparks and flames away from all fuel-related parts.

Maintenance Schedule

Remember that this schedule is based on the assumption that your machine will be used for its designed purpose. Sustained high-load or high-temperature operation, or use in unusually wet or dusty conditions, will require more frequent service.

REGULAR SERVICE PERIOD (1)			Before Each Use	First Month or 20 Hours	Every 3 Months or 50 Hours	Every 6 Months or 100 Hours	Every year or 300 Hours	
ITEM		Performed at every indicated month or operating hour interval, whichever comes first						
•	Engine Oil	Check	✓					
		Change		✓		✓		
•	Air filter	Check	✓					
		Change			✓ (2)			
•	Sediment Cup	Clean				✓		
•	Spark Plug	Check				✓		
		Change						
•	Spark Arrester	Clean				✓		
•	Idle Speed	Check-Adjust					✓	
•	Valve Clearance	Check-Adjust					✓	
•	Combustion Chamber	Clean	After every 500 hours					
•	Fuel tank and filter	Clean				✓		
•	Fuel Tube	Check	Every 2 years (replace if necessary)					

(1) For commercial use, log hours of operation to determine proper maintenance intervals.

(2) Service more frequently when used in dusty areas.

Engine Oil Change

Drain the oil while the engine is warm to assure rapid and complete draining.

- Remove the drain plug and sealing washer, remove the oil filler cap and drain the oil.
- Reinstall the drain plug and sealing washer. Tighten the plug securely.
- Refill with the recommended oil and check the oil level
- Wash your hands with soap and water after handling used oil.

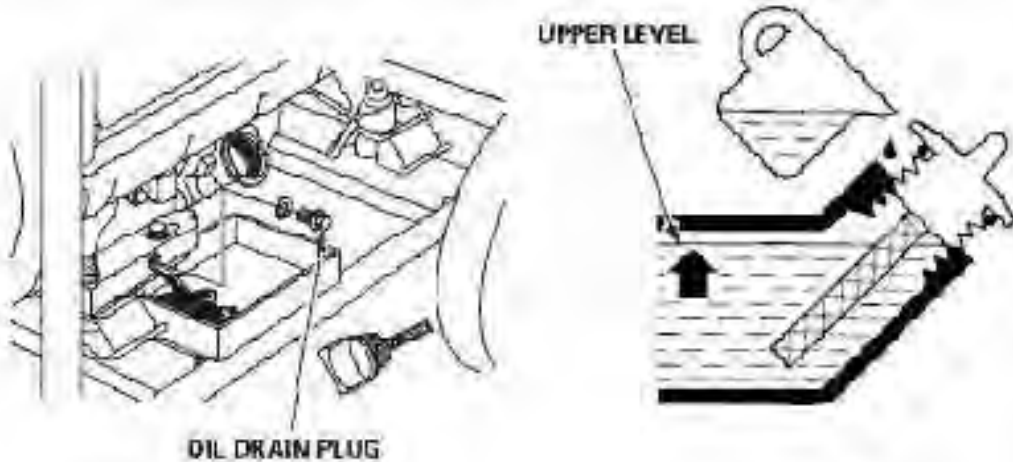

Air Filter Service

A dirty air filter will restrict air flow to the carburetor. To prevent carburetor malfunction, service the air filter regularly. Service more frequently when operating the generator in extremely dusty areas.

- Unscrew the air filter cover clips, remove the air filter cover and remove the element.
- Wash the air filter element in a solution of household detergent and warm water, then rinse thoroughly, or wash in nonflammable or high flashpoint solvent. Allow the air filter element to dry thoroughly.
- Soak the air filter element in clean engine oil and squeeze out the excess oil. The engine will smoke during initial startup if too much oil is left in the air filter element.
- Reinstall the air filter element and the cover.

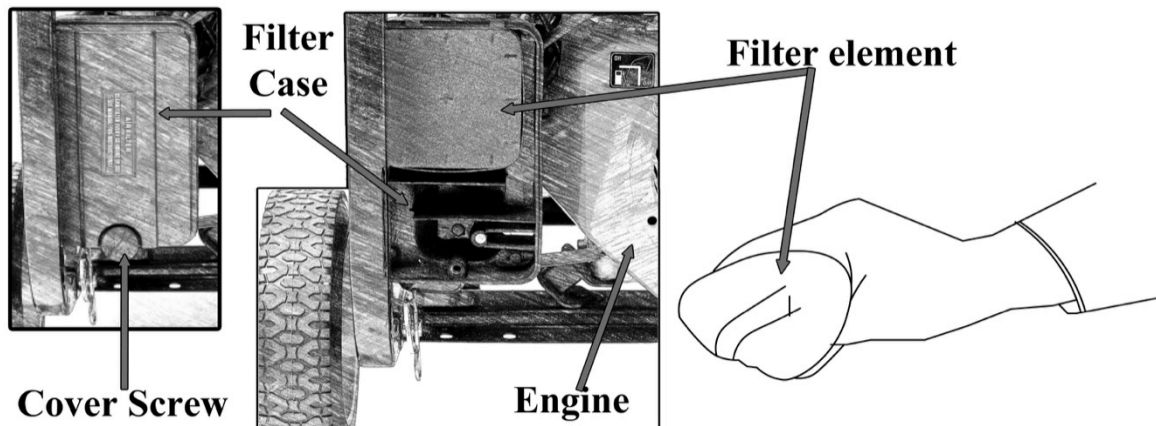

Never run the generator without the air filter. Rapid engine wear will result.

Fuel Sediment Cup Cleaning

The sediment cup prevents dirt or water, which may be in the fuel tank from entering the carburetor. If the engine has not been running for a long time, the sediment cup should be cleaned.

- Turn the fuel valve to the OFF position. Remove the sediment cup, O-ring and filter.
- Clean the sediment cup, O-ring and filter in nonflammable or high flash point solvent.
- Reinstall the filter, O-ring and sediment cup.
- Turn the fuel valve lever ON and check for leaks.

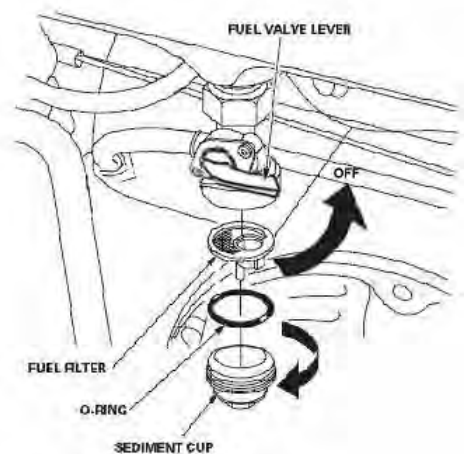

Spark Plug Service

To ensure proper engine operation, the spark plug must be properly gapped and free of deposits. If the engine has been running, the muffler will be very hot. Be careful not to touch the muffler.

- Remove spark plug cap.
- Clean any dirt from around the spark plug base.
- Use a spark plug wrench to remove the spark plug.
- Visually inspect the spark plug. Discard it if the insulator is cracked, chipped or fouled.
- Measure the plug gap with a feeler gauge. Correct as necessary by carefully bending the side electrode.

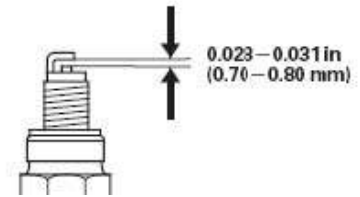

The gap should be: 0.028 0.031 inches (0.70 0.80 mm)

- Check that the spark plug washer is in good condition. Thread the spark plug in by hand to prevent cross-threading.
- After the spark plug is seated, tighten with the spark plug wrench to compress the washer.
 - If installing a new spark plug, tighten ½ turn after the spark plug seats to compress the washer. If reinstalling a used spark plug, tighten ⅛ - ¼ turn after the spark plug seats to compress the washer.



Caution: The spark plug must be securely tightened. An improperly tightened spark plug can become very hot and could damage the engine. Never use spark plugs which have an improper heat range. Use only recommended spark plugs or equivalent.

Spark Arrester Maintenance

If the generator has been running, the muffler will be very hot. Allow it to cool before proceeding.



The spark arrester must be serviced every 100 hours to maintain its efficiency. Clean the spark arrester as follows:

- Loosen the screw by the exhaust port of the muffler and remove the spark arrester.
- Use a brush to remove carbon deposits from the spark arrester screen. Inspect the screen for breaks or tears and replace it if necessary.
- Install the spark arrester in the reverse order of removal.

INSPECTION, CLEANING AND MAINTENANCE



WARNING! ALWAYS MAKE SURE THE ENGINE POWER SWITCH IS IN ITS “OFF” POSITION. DISCONNECT THE SPARK PLUG WIRE FROM THE ENGINE. AND ALLOW SUFFICIENT TIME FOR THE ENGINE AND GENERATOR TO COMPLETELY COOL BEFORE PERFORMING ANY INSPECTIONS, MAINTENANCE OR CLEANING.

- Before each use, inspect the generator. Check for:
 - Loose screws
 - Misaligned or bound moving parts

- Cracked or broken parts
 - Damaged electrical wiring
 - Any other condition that may affect safe operation.
- If an engine problem occurs, have it checked by a qualified service technician before further use. Do not use damaged equipment.
 - Before each use, remove all debris with a soft brush, rag, or vacuum.
 - Lubricate all moving parts using premium quality, lightweight machine oil.
 - Every 50 hours of use, drain the old engine oil and replace with a high quality SAE 10W-30 grade engine oil.
 - Every 300 hours of use, have a qualified, certified technician perform thorough maintenance on the generator and engine.
 - For long term storage, either drain fuel into suitable container or add a fuel preservative/stabilizer (not included) to prevent fuel breakdown.
 - After each use, unplug all tools and equipment from the generator.
 - After the engine and generator have completely cooled, store the generator in a safe, clean and dry location (if not permanently installed).

STORAGE

Before storing the unit for an extended period:





- Be sure the storage area is free of excessive humidity and dust.
- Service according to the table below:

STORAGE TIME	RECOMMENDED SERVICE PROCEDURE
Less than 1 month	No preparation required.
1 to 2 months	Fill with fresh gasoline and add gasoline conditioner.
2 months to 1 year	Fill with fresh gasoline and add gasoline conditioner. Drain the carburetor float bowl. Drain the fuel sediment cup.
1 year or more	Fill with fresh gasoline and add gasoline conditioner. Drain the carburetor float bowl. Drain the fuel sediment cup. Remove the spark plug and put a tablespoon of engine oil into the cylinder head. Pull recoil starter slowly to distribute the oil evenly in the cylinder. Reinstall the spark plug. Change the engine oil. After removal from storage, drain the stored gasoline into a suitable container and fill the generator tank with fresh gasoline before starting.

INSTALLATION

Your generator may be installed as part of an Automatic Generator System (AGS) but should only be done so by a certified electrician and licensed contractor. Note the following if you decide to permanently install your generator:

	<p>Electrical and other permits may be required for the installation of emergency power systems. Investigate your local building and electrical codes before installing this unit. Installation must be completed by a certified electrician and licensed contractor.</p>
---	---

	<p>Prior to powering tools and equipment make sure the generator's rated voltage, wattage and amperage capacity is adequate to supply all electrical loads that the unit will power. If powering exceeds the generator's capacity, it may be necessary to group one or more of the tools and/or equipment for connection to a separate generator.</p>
	<p>WARNING! THE GENERATOR WEIGHS APPROXIMATELY 110 POUNDS. USE CARE AND THE PROPER LIFTING OR HOISTING EQUIPMENT WHEN MOVING IT TO THE INSTALLATION LOCATION. ALWAYS CONNECT HOIST LINES TO THE FRAME OF THE GENERATOR.</p>
	<p>Make sure to locate and install the generator outdoors where cooling air is readily available.</p> <p>Install the generator so that the air inlets and outlets are not blocked by obstructions such as bushes, trees, or snow drifts. Locating it in the path of heavy winds or snowdrifts may require the placement of a barrier for protection. In normal weather conditions, the air vent should face the prevailing wind direction.</p> <p>Install the generator on a concrete slab or other area where rain drainage or floodwaters cannot reach it.</p> <p>Generator placement should allow four feet of access to all sides for maintenance.</p> <p>Place the generator as close as possible to the electrical tools and equipment being powered to reduce the length of extension cords.</p>
	<p>Mount the generator on a concrete slab capable of supporting the weight of the generator. The slab must extend on all sides beyond the frame by at least one foot. Contact a cement contractor for slab specifications if necessary. Attach the frame to the concrete slab using 3/8" diameter expansion anchor bolts (not supplied).</p>
	<p>Connect a #6 AWG grounding wire (not included) from the ground connector (8) on the generator to a grounding rod (not included) that has been driven at least 24 inches deep into the earth. The grounding rod must be an earth-driven copper or brass rod (electrode) which can adequately ground the generator.</p>

After installation, check the total rated and peak wattage of the connected appliances to ensure the generator is not overloaded. With an AGS, if the main electric supply is cut, the generator will cut off the outside circuit and automatically start itself to provide electricity to the connected appliances. Once the main power supply is restored, the generator will shut off itself and reconnect the circuit automatically.

	<p>If the generator does not start, follow the troubleshooting guidelines for the generator but do not attempt to repair the AGS connections unless you are a certified electrician. Contact the agent who installed the AGS the troubleshooting guidelines do not resolve the problem.</p>
---	---

TROUBLESHOOTING

Note: Troubleshooting problems may have similar causes and solutions.

PROBLEM	POSSIBLE CAUSE	SOLUTION
The engine will not start	Lack of fuel	<p>Check the fuel in the tank. Add more if necessary.</p> <p>Confirm the fuel valve is On (vertical).</p>
	Low oil	Check the oil level. Add oil if necessary.
	Damaged Spark Plug	Remove and check that the spark plug is in good condition. Replace if necessary.
	Carburetor needs to be choked	Rotate the choke lever to fully close the choke.
	Spark plug damaged	Readjust gap and dry the spark plug. Replace if necessary.
	Carburetor dirty	<p>Clean the fuel sediment cup.</p> <p>Replace or service the carburetor</p>
No electricity to the AC receptacles	AC circuit breaker is off	Switch it on.
	Electrical appliance is damaged	Replace the electrical appliance or equipment.
	Electrical circuit or plugs have been damaged.	Take the unit in to an authorized dealer or service center.

If the engine still does not start, take the generator to an authorized dealer or service center.

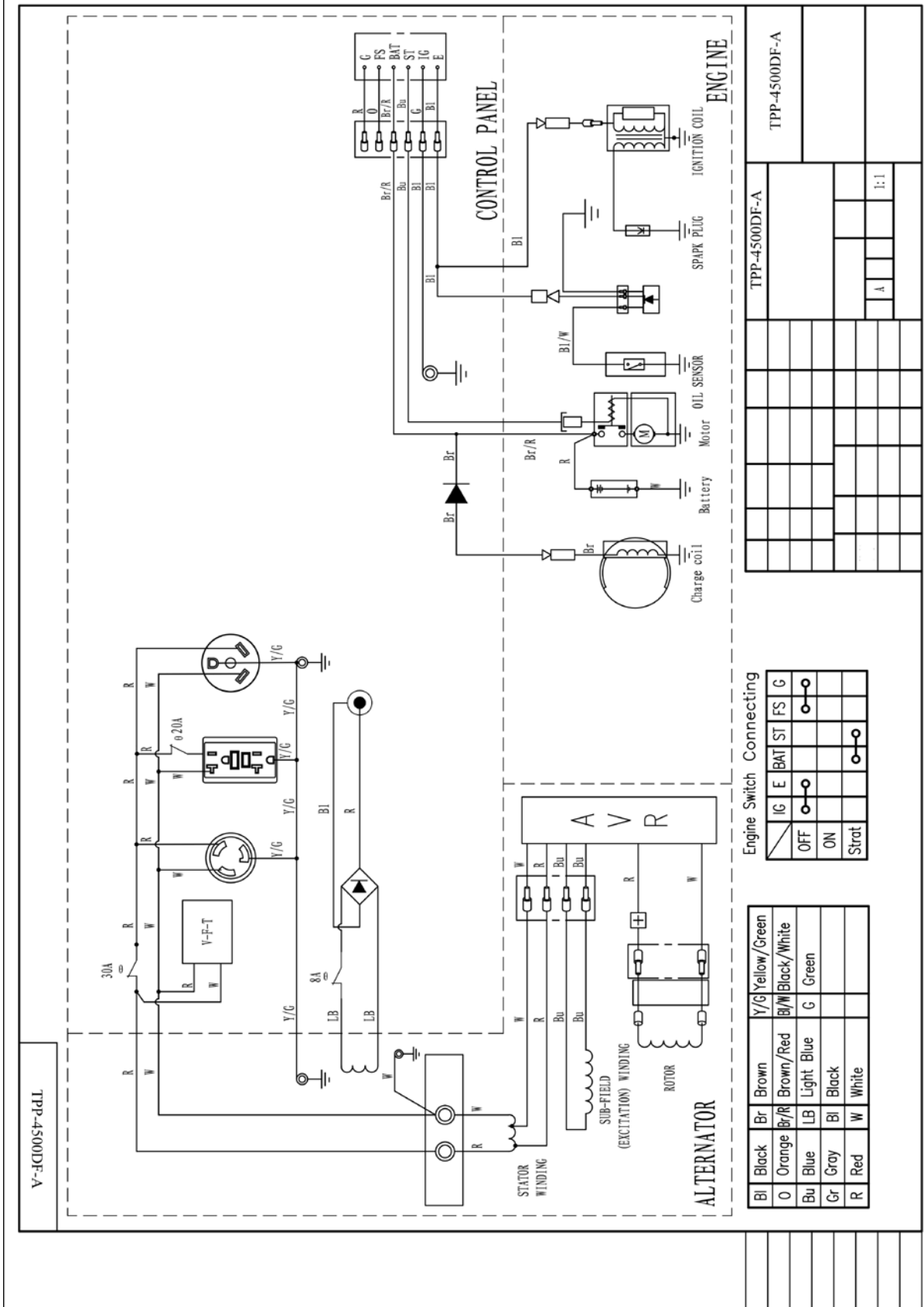

Tillotson Power Products Model Guide

Unit No.	TPP-4500G-A	TPP-4500DF-A	TPP-7500G-A	TPP-7500DF-A	TPP-10000G-A
Fuel	Gasoline	LP/Gas	Gasoline	LP/Gas	Gasoline
Rated Peak Wattage	4500	4500	7500	7500	10,000
Rated Wattage	3500	3500	6000	6000	7500
Engine CC	208 CC	208 CC	420 CC	420 CC	420 CC
Engine HP	7 HP	7 HP	15 HP	15 HP	15 HP
Low Oil Shut Off	Yes	Yes	Yes	Yes	Yes
Fuel Gauge	Yes	Yes	Yes	Yes	Yes
Tank Capacity Gallons	4 Gal	4 Gal/25lb	6.6Gal	6.6Gal/25lb	6.6 Gal
Full Load Gallons/Hour	.36 GPH	.36 GPH	.5 GPH	.5 GPH	.63 GPH
Run Time at Half Load	11 hours	11 hours	12 hours	12 hours	10.5 hours
Noise Level	72 dB	72 dB	75 dB	75 dB	76 dB
Frame					
Wheel Kit	Yes	Yes	Yes	Yes	Yes
No Flat Tires	Pneumatic No Flat	Pneumatic No Flat	Pneumatic No Flat	Pneumatic No Flat	Pneumatic No Flat
Frame	Tubular Steel	Tubular Steel	Tubular Steel	Tubular Steel	Tubular Steel
Paint	Powder Coat	Powder Coat	Powder Coat	Powder Coat	Powder Coat
Handles	Dual Drop	Dual Drop	Dual Drop	Dual Drop	Dual Drop
Electrical					
Automatic Voltage Regulation	Yes	Yes	Yes	Yes	Yes
Battery	Maintenance Free	Maintenance Free	Maintenance Free	Maintenance Free	Maintenance Free
Digital Hour Meter	Yes	Yes	Yes	Yes	Yes
Volt Meter	Yes	Yes	Yes	Yes	Yes
GFCI Outlets	Yes	Yes	Yes	Yes	Yes
Outlet Covers	Yes	Yes	Yes	Yes	Yes
Overload Protection	Yes	Yes	Yes	Yes	Yes
Starter Type	Remote/Electric/ Recoil	Recoil/Electric	Remote/Electric/ Recoil	Electric/Recoil	Remote/Electric/ Recoil
Voltage Rating	120V	120V	120/240V	120/240V	120/240V
Amperage (120V Rated/Peak)	29A/35.5A	29A/35.5A	50A/62.5A	50A/62.5A	67A/83A
Amperage (240V Rated/Peak)	14.5A/19A	14.5A/19AGas/13 A/17ALP	25A/31A	25/31G/22.5/28LP	33A/42A
120V Outlets	2	2	4	4	4
120V Twist Outlet	1	1	1	1	1
120V/240 Twist			1	1	1
12V Outlets	1	1	1	1	1
30 AMP RV	1	1			1
Certification					
EPA/CARB	Yes/Yes	Yes/No	Yes/Yes	Yes/No	Yes/Yes
Product Dimensions					
Length	24.6"	24.6"	28.1"	28.1"	28.1
Width	17.1"	17.1"	21.6"	21.6"	21.6"
Height	18.5"	18.5"	22.4"	22.4"	22.4"
Net Weight	122 lbs	120 lbs	190 lbs	192 lbs	212.7 lbs
Warranty					
Parts/Labor	2 yr/1yr	2 yr/1yr	2 yr/1yr	2 yr/1yr	2 yr/1yr