

Key Features

- Manufactured in Greensboro, North Carolina, USA.
- Heavy duty generator system designed for prime power operation in rental, construction and special events applications.

Skidbase and Enclosure

- Package foundation is a heavy duty, oilfield-ready skidbase designed with minimum 110% environmental containment to prevent any leakage of fuel, oil, or coolant.
- Optimized package design combines low noise levels with small footprint and full load performance capability in high ambient temperatures.
- The enclosure is coated with a 2 part epoxy over the zinc plated steel for superior corrosion resistance and a high gloss powder paint for long life.
- Wide opening side access doors are hinged, providing easy access and are equipped with recessed, pad-lockable handles.
- Package is equipped with a center-point lifting eye for safe, well-balanced hoisting, designed with a 5 x safety factor for the weight of a fully fueled unit with running gear.

Engine and Cooling System

- Industrial, heavy-duty diesel engine is emissions certified to current EPA and CARB requirements and provides optimum mix of performance and fuel economy.
- Electronically controlled engine provides isochronous frequency control and advanced diagnostic monitoring and protection.
- Oversized cooling system rated for high ambient temperature

(minimum 40°C/104°F) operation without de-rating.

- The engine generator assembly is mounted on fail-safe vibration isolators.
- Coolant and oil drains are piped to bulkhead fittings mounted on the enclosure and all filters and maintenance points are easily accessed for safe and easy servicing.
- Engines are globally supported by the engine OEM and Clarke Power Generation, Inc.



Generator

- Leroy Somer alternators feature AREP brushless excitation providing industry leading motor starting kVA and 300% overload capability.
- Class H insulation with upgraded environmental coating for ultimate resistance to high temperature and humidity.
- Three position Voltage Selector Switch (VSS) to easily configure the units for operation at most common voltages.

Voltage / Frequency	P.F.	Armature Connection	Rating	Amps	kW	kVA
480V-3Ø-60Hz	0.8	Series Wye	Prime	113	75	94
			Standby	124	83	103
240V-3Ø-60Hz	0.8	Parallel Wye	Prime	226	75	94
			Standby	249	83	103
208V-3Ø-60Hz	0.8	Parallel Wye	Prime	236	68	85
			Standby	260	75	94
240V-1Ø-60Hz	1.0	Zig-Zag	Prime	221	53	53
			Standby	243	58	58
120V-1Ø-60Hz	1.0	Zig-Zag	Prime	221 × 2	53	53
			Standby	243 × 2	58	58

Control System

- Digital control provide at-a-glance monitoring and simple access of vital engine and generator parameters. Micro-processor-controlled startup at the push of a button and protects the generator system from an array of faults while providing the operator with clear communication.
- Engine fault codes are displayed on the main LCD display, providing operators and technicians with a numeric and text explanation of the fault code, minimizing the need for expensive hand-held code scanners.
- Standard remote Auto Start / Stop capability via two wire, closed contact logic, allows for connection to automatic transfer switchgear and other remote starting devices.
- Industry exclusive Voltage Selector Switch (VSS) protection feature prevents switching the VSS while generator is operating.
- Battery disconnect switch is mounted inside the enclosure.

Power Connections

- All controls and connection points are grouped at the rear of the unit for safety and operator convenience.
- Power cables are connected at an oversized five lug (L1 L2 L3 N PE) terminal board capable of accepting bare end cable or terminated cables.
- Convenience receptacle panel includes individual branch circuit breakers.

Fuel System

- Single fuel tank sized for 24 hour runtime is mounted within the skid base, providing double wall protection.
- Fuel tank mounted low in frame and centered to ensure balanced lifting and low center of gravity.
- The fuel filler is located within the containment basin, minimizing possible spillage.

- Standard Racor-style fuel / water separator and fine micron secondary fuel filter keep contaminants out of the system and increase reliability.
- The containment system features a three-inch drain plug for easy cleaning, and the fuel tank has a drain plug mounted behind the containment plug.
- Leak-proof fuel vents eliminate the potential for fuel purge during out-of-level conditions during transport and load / unload.
- Low fuel shutdown ensures the engines will not lose prime if they run out of fuel.

Running Gear

- Integrated running gear system mounts directly to generator skidbase providing an industry-best low center of gravity for safe, stable towing, on-road or off-road.
- Tandem axle torsion suspension with E-Z-Lube hub assemblies and choice of electric or hydraulic surge brakes.
- All models feature high quality, grommet-mount lighting and meet Federal Motor Vehicle Safety Standards for lighting and conspicuity.
- Trailer-to-vehicle connector is a 6-pole round plug with a high quality, jacketed wiring harness.
- All units are equipped with a 3-inch pintle eye, wheel chocks and a high quality, heavy-duty jack stand.

Warranty

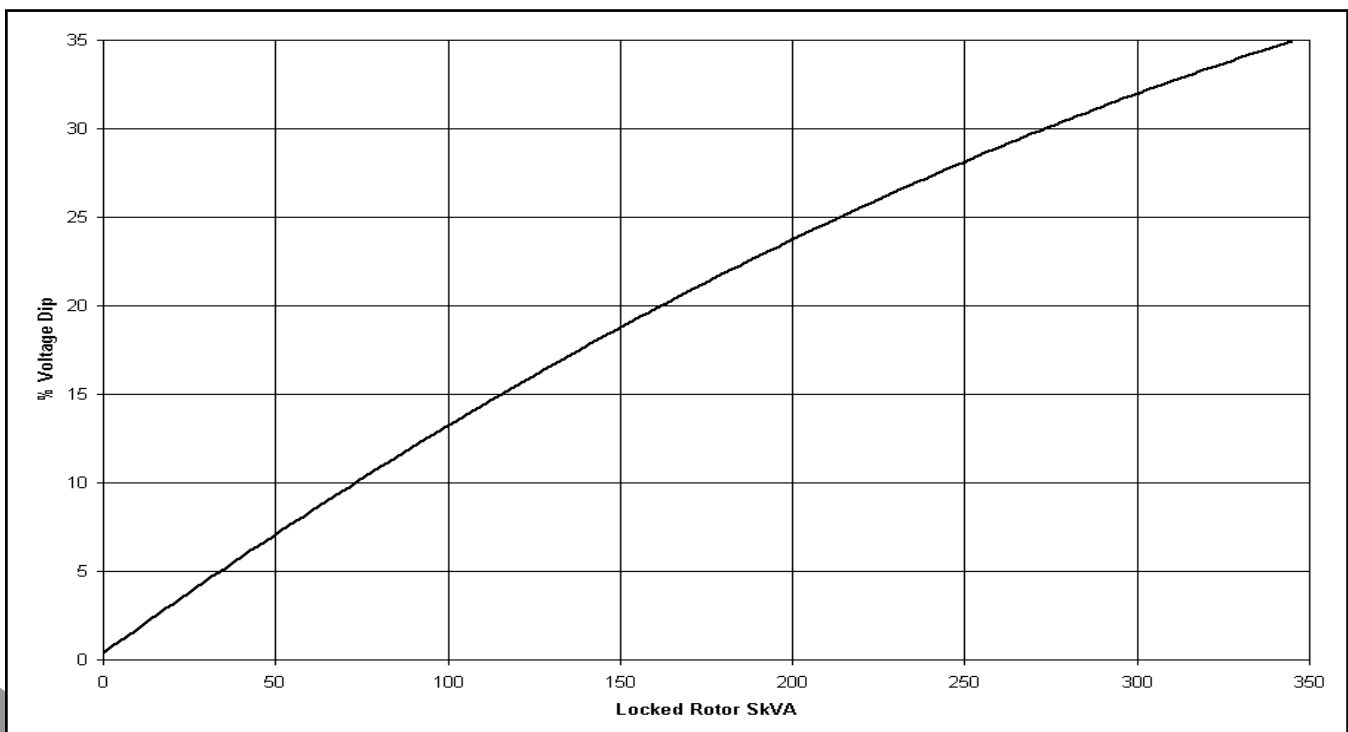

- All models are covered by a comprehensive limited warranty:
- Package: 1 year / 2000 hours
- John Deere Engine: 1 year / unlimited hours or 2 years / 4000 hours
- Leroy Somer Alternator: 2 years / 4000 hours

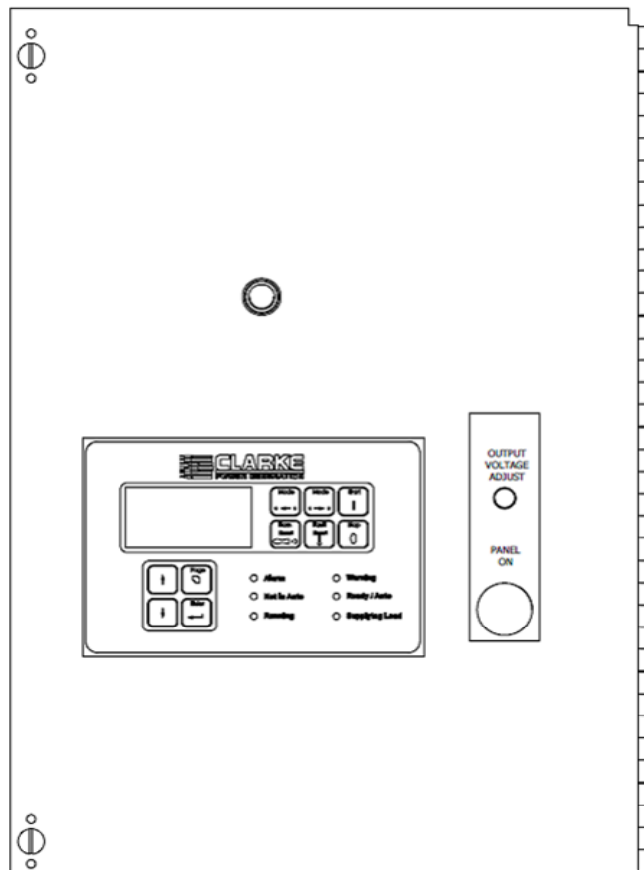

RC90D-T3 *Mobile Prime Generators*

Engine Data	
Engine Manufacturer	John Deere
Model Number	4045HF285
Prime Output @ Rated Speed	115 HP 86 kWm
Standby Output @ Rated Speed	126 HP 94 kWm
Engine Type	Inline 4-cycle
Engine Control	ECU
Emissions Certification	EPA Tier 3
Number of Cylinders	4
Aspiration	Turbocharged / Intercooled
Bore × Stroke	4.2 × 5.0 in 106 × 127 mm
Displacement	275 in ³ 4.5 L
Compression Ratio	19 : 1
Governor Type	Electronic / Isochronous
Speed Regulation Accuracy	+ / - 0.25% Steady State
Single Step Load Acceptance	100%
Cooling System	50% Glycol / 50% Water
Charging Alternator Output	70 A
DC System Voltage	12 V
Battery Output	1000 CCA



Fluid Capacities		Gal	L
Oil Sump Capacity		3.57	13.5
Cooling System Capacity		7.5	28.4
Usable Fuel Cell Capacity		171.6	649.6
Fuel Consumption	Gal / h	L / h	Runtime
@ 25% Load	2.30	8.71	74.6
@ 50% Load	4.13	15.63	41.5
@ 75% Load	5.94	22.49	28.9
@ 100% Load	7.69	29.11	22.3
Alternator Data			
Alternator Manufacturer		Leroy Somer	
Alternator Model		LSA 432 L8	
Alternator Type		Four Pole Revolving Field	
Number of Leads		12	
Insulation Class		H	
Frequency		60 Hz	
Available Voltages—3Ø		208 / 240 / 416 / 480 V	
Available Voltages—1Ø		120 / 139 / 240 / 277 V	
Voltage Connection Method		3-Position Selector Switch	
Excitation Method		Brushless with AREP	
Voltage Regulator Model		R438	
Voltage Regulation Accuracy		+ / - 0.5% Steady State	
Total Harmonic Distortion (THD)		<5% @ No Load	
Telephone Influence Factor (TIF)		<50	
Power Connections		Qty	
20A—125V GFCI Duplex (NEMA 5-20R)			2
50A—125/250V Temp Power (CS6369)			3
Terminal Board Maximum Cable Size (Bare Wire)		350 MCM	
Terminal Board Maximum Cable Size (Lugged)		350 MCM	
Reference Conditions			
Rated Ambient Temperature		10°-104°F	-12°-40°C
Minimum Starting Temperature (Standard)		10°F (-12°C)	
Minimum Starting Temperature (w/ Cold Start Opt)		0°F (-18°C)	
Rated Altitude			
Temperature De-rate Factor			
Altitude De-rate Factor			

RC90D-T3 *Mobile Prime Generators*

Running Gear	To 49CFR571 requirements	
Configuration	Tandem axle	
Suspension	Torsion bar	
Standard Brake System Configuration	Electric (hydraulic surge brakes optional)	
Tires	ST205/75D15	
Wheels	15" x 6" (381 mm x 152 mm), 6 lug on 5.5" (140 mm) bolt circle	
Lighting and Reflectors	Meets FMVSS 571.108 requirements	
Electrical Connection to Towing Vehicle	Six pole round plug	
Standard Coupling Connection	3" (76 mm) Pintle eye (2-5/16" (59 mm) ball coupler optional)	
Hitch Height	20-22-24-26-28 in	508-559-610-660-711 mm
Safety Chains	2 x 5/16" (8 mm) Chains with slip hooks and safety latches	
Jack Stand Configuration	5,000lb (2,268 kg) Capacity, top wind with sand shoe, trunion mounted	
Weights & Dimensions (w/ Running Gear)		
Length	165.8 in	4,211 mm
Width	71.7 in	1,821 mm
Height	83.6 in	2,123 mm
Weight (Shipping)	5,004 lb	2,270 kg
Weight (Ready to Run)	6,466 lb	2,933 kg
Weights & Dimensions (Less Running Gear)		
Length	107.1 in	2,721 mm
Width	47.8 in	1,214 mm
Height	69.4 in	1,764 mm
Weight (Shipping)	4,111 lb	1,865 kg
Weight (Ready to Run)	5,573 lb	2,528 kg
Sound Level @ 23ft (7m), 100% Load	68 dB(A)	

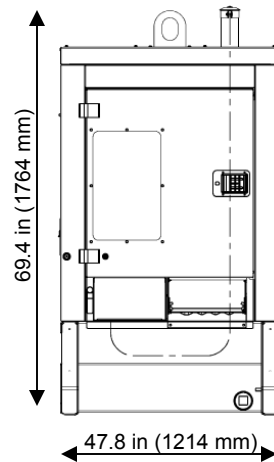
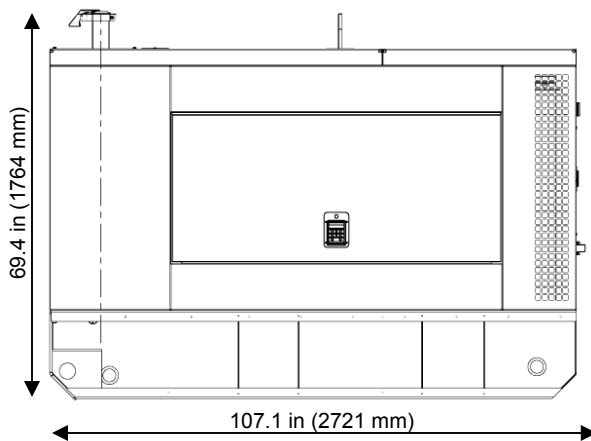
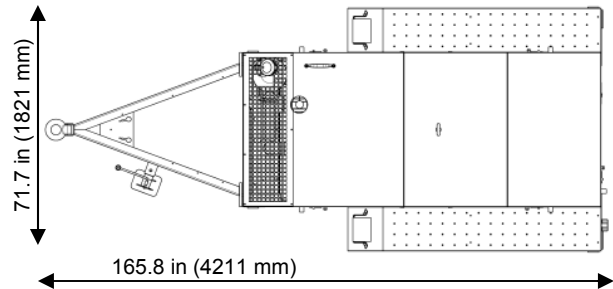
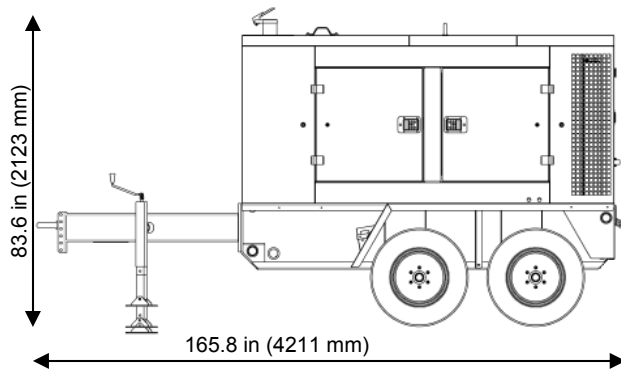

CLARKE®



Power Generation, Inc.

Due to continuous product improvement, specifications subject to change without notice.

Clarke Power Generation, Inc.
8015 Piedmont Triad Pkwy.
Greensboro, NC 27409

866.334.4367
clarkegen.com

© 2014 Clarke Power Generation, Inc. G131727 REV A