



Generator

OWNER'S MANUAL



Read this manual carefully before operating this machine.

EF4500iSE

LIT-19626-01-72

7XF-28199-12

WARNING

The engine exhaust from this product contains chemicals known to the State of California to cause cancer, birth defects or other reproductive harm.

YAMAHA

LIT-CALIF-65-01

 **Read this manual carefully before operating this machine. This manual should stay with this machine if it is sold.**

INTRODUCTION

Congratulations on your purchase of your new Yamaha.

This manual will provide you with a good basic understanding of the operation and maintenance of this machine.

If you have any questions regarding the operation or maintenance of your machine, please consult a Yamaha dealer.

EF4500iSE

OWNER'S MANUAL

© 2011 by Yamaha Motor Corporation, U.S.A.

1st Edition, February 2011

All rights reserved.

**Any reprinting or unauthorized use
without the written permission of
Yamaha Motor Corporation, U.S.A.
is expressly prohibited.**

Printed in Japan

P/N LIT-19626-01-72

IMPORTANT MANUAL INFORMATION

Particularly important information is distinguished in this manual by the following notations.



This is the safety alert symbol. It is used to alert you to potential personal injury hazards. Obey all safety messages that follow this symbol to avoid possible injury or death.

WARNING

A WARNING indicates a hazardous situation which, if not avoided, could result in death or serious injury.

NOTICE

A NOTICE indicates special precautions that must be taken to avoid damage to the machine or other property.

TIP

A TIP provides key information to make procedures easier or clearer.

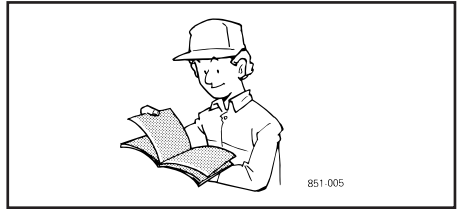

WARNING

PLEASE READ AND UNDERSTAND THIS MANUAL COMPLETELY BEFORE OPERATING THE MACHINE.

TIP

- Yamaha continually seeks advancements in product design and quality. Therefore, while this manual contains the most current product information available at the time of printing, there may be minor discrepancies between your engine and this manual. If there is any question concerning this manual, please consult a Yamaha dealer.
- This manual should be considered a permanent part of this engine and should remain with this engine when resold.

* Product and specifications are subject to change without notice.

CONTENTS

| | | | |
|---|----|---|----|
| SAFETY INFORMATION | 1 | Air filter | 26 |
| Exhaust fumes are poisonous | 2 | Muffler screen and spark arrester..... | 28 |
| Fuel is highly flammable and poisonous | 2 | Fuel tank filter | 30 |
| Engine and muffler may be hot..... | 2 | Battery | 31 |
| Electric shock prevention..... | 3 | Recommended battery | 31 |
| Connection notes..... | 4 | Fuse replacement..... | 32 |
| Connection | 4 | STORAGE | 33 |
| Extension cord notes | 4 | Drain the fuel | 33 |
| LOCATION OF IMPORTANT LABELS | 5 | Engine | 35 |
| DESCRIPTION | 7 | Battery | 36 |
| Control panel | 7 | TROUBLESHOOTING | 38 |
| CONTROL FUNCTION | 8 | SPECIFICATIONS | 41 |
| Engine switch | 8 | Dimensions..... | 41 |
| Oil warning light (red) | 8 | Engine | 41 |
| AC protector | 9 | Generator | 41 |
| Hour meter..... | 9 | Battery | 41 |
| Power meter | 9 | CONSUMER INFORMATION | 42 |
| AC pilot light (green)..... | 10 | Identification number records | 42 |
| Overload indicator light (red) | 10 | Machine identification..... | 42 |
| Fuel tank cap | 11 | EXHAUST EMISSION CONTROL SYSTEM AND COMPONENTS | 43 |
| Fuel cock knob | 11 | WIRING DIAGRAM | 45 |
| Ground (earth) terminal | 11 | YAMAHA MOTOR CORPORATION, U.S.A. | |
| Caster lock lever..... | 11 | EF SERIES GENERATORS | |
| PREPARATION | 12 | 3-YEAR LIMITED WARRANTY | 47 |
| Fuel..... | 12 | YAMAHA OUTDOOR POWER EQUIPMENT | |
| Engine oil..... | 13 | CALIFORNIA EVAPORATIVE EMISSION CONTROL | |
| Battery preparation | 14 | WARRANTY STATEMENT | 50 |
| PRE-OPERATION CHECK | 16 | YAMAHA MOTOR CORPORATION, U.S.A. | |
| Pre-operation check | 16 | SMALL OFF ROAD ENGINES | |
| OPERATION | 17 | CALIFORNIA EMISSION CONTROL WARRANTY | 51 |
| Starting the engine | 17 | YAMAHA EXTENDED SERVICE (Y.E.S.) | 55 |
| Stopping the engine..... | 18 | | |
| Connection | 19 | | |
| Application range..... | 20 | | |
| PERIODIC MAINTENANCE | 21 | | |
| Maintenance chart | 21 | | |
| Spark plug inspection | 23 | | |
| Carburetor adjustment..... | 25 | | |
| Engine oil replacement | 25 | | |

SAFETY INFORMATION

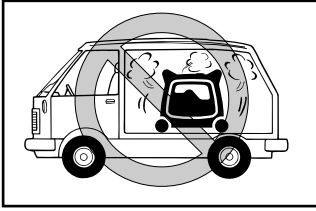

- This generator is not designed for on-board use. Do not use it while installed on the vehicle.

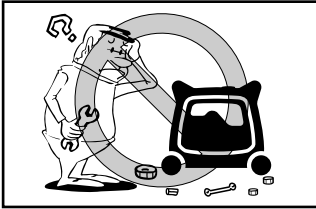

- Do not modify the generator or use it with its parts removed.

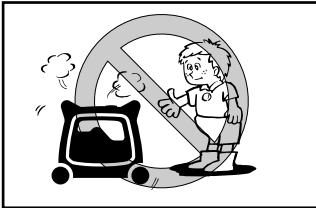

- Do not allow children to operate the generator.

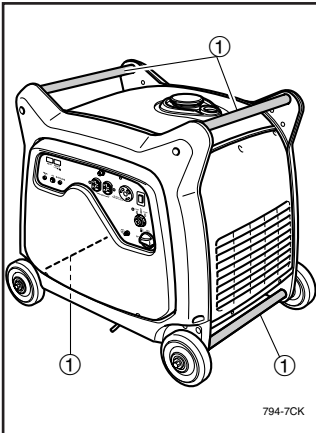

- Be sure to carry the generator only by its carrying handles.

① Carrying handles (shaded)

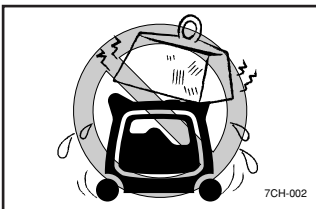

- Do not place any obstacles on the generator.



Exhaust fumes are poisonous

- Never operate the generator in a closed area or it may cause unconsciousness and death within a short time. Operate the generator in a well ventilated area.

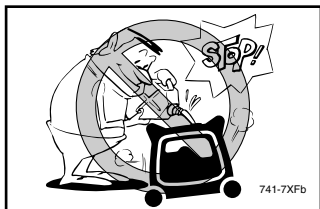

Fuel is highly flammable and poisonous

- Always turn off the generator when refuelling.
- Never refuel while smoking or in the vicinity of an open flame.
- Take care not to spill any fuel on the engine or muffler when refuelling.
- Do not leave the generator inside the vehicle or in the trunk.
- If you swallow any fuel, inhale fuel vapor, or allow any to get in your eye(s), see your doctor immediately. If any fuel spills on your skin or clothing, immediately wash with soap and water and change your clothes.

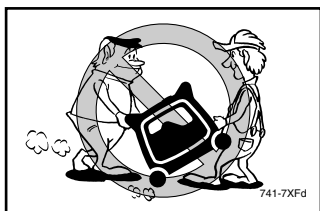

- When operating or transporting the generator, be sure it is kept upright. If it tilts, fuel may leak from the carburetor or fuel tank.

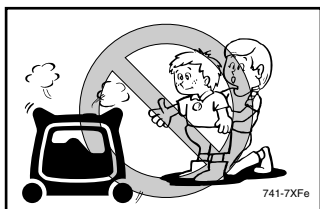

Engine and muffler may be hot

- Place the generator in a place where pedestrians or children are not likely to touch the generator.
- Avoid placing any flammable materials near the exhaust outlet during operation.



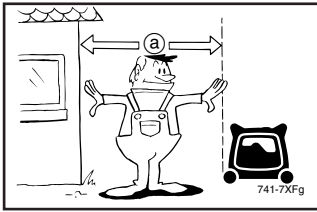

- Keep the generator at least 1 m (3 ft) from buildings or other equipment, or the engine may overheat.

Ⓐ 1 m (3 ft)

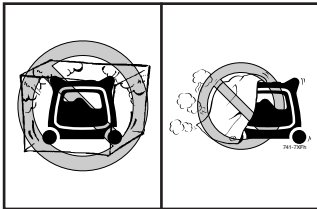

- Do not operate the generator with a dust cover or other objects covering it.
- When covering the generator, be sure to do so only after the engine and muffler have completely cooled down.



Electric shock prevention

- Never operate the generator in rain or snow.



- Never touch the generator with wet hands or electrical shock will occur.

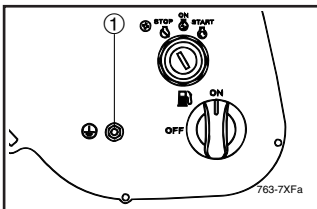

- Connect the ground lead of the generator to the ground (earth) terminal and connect the end to the ground electrode buried in the ground.

① Ground (earth) terminal

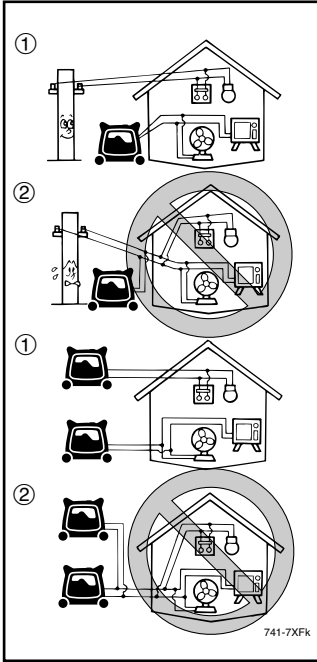

Connection notes

- Avoid connecting the generator to commercial power outlet.
- Avoid connecting the generator in parallel with any other generator.

- ① Correct
- ② Incorrect

Connection

⚠ WARNING

Before the generator can be connected to a building's electrical system, a licensed electrician must install an isolation (transfer) switch in the building's main fuse box. The switch is the connection point for generator power and allows selection of generator or main line power to the building. This will prevent the generator from charging the main power line (backfeeding) when the main power supply has failed or has been turned off for line repair. Backfeeding can electrocute or injure line maintenance personnel. Also, generator and building electrical system damage can occur when normal operating power returns if unit is used without an isolation switch.

Extension cord notes

Extension cords should be protected by a tough flexible rubber sheath (IEC 245) or the equivalent to withstand mechanical stresses.

LOCATION OF IMPORTANT LABELS

Please read the following labels carefully before operating this generator.

TIP

Maintain or replace safety and instruction labels, as necessary.

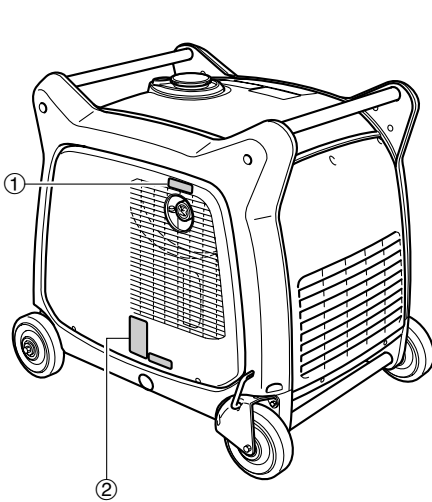

①

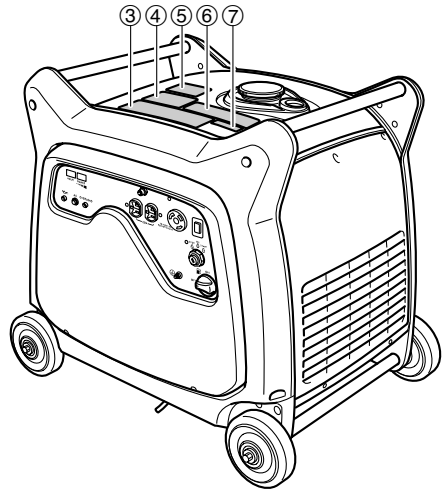

②

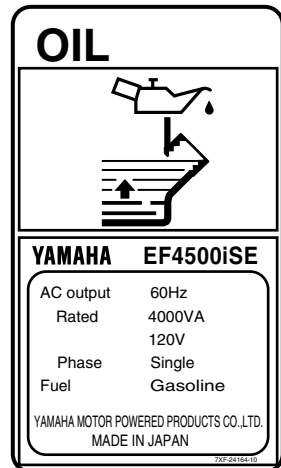

③

| | |
|--|--|
| ⚠ WARNING | ⚠ AVERTISSEMENT |
| <ul style="list-style-type: none"> ● Read the owner's manual and all labels before operating ● Only operate in well-ventilated areas . ● Exhaust gas contains poisonous carbon monoxide. ● Check for spilled fuel or fuel leaks. ● Stop engine before refueling. ● Do not Operate near flammable materials. ● Electrocutation can occur if generator is used in rain, snow, or near water, keep this unit dry at all times . ● When operating the generator: Never place a partition or other barrier around the generator. Do not cover the generator with a box. Do not place any objects on the generator. | <ul style="list-style-type: none"> ● Lisez le mode d'emploi et toutes les étiquettes avant de faire fonctionner la machine. ● Faites fonctionner uniquement dans des lieux bien aérés. ● Les gaz d'échappement contiennent du monoxyde de carbone. ● Vérifiez si du carburant a été renversé ou s'il fuit. ● Arrêtez le moteur avant de faire le plein de carburant. ● N'utilisez pas à proximité de matériaux inflammables. ● Il y a risque d'électrocution si le générateur fonctionne sous la pluie, dans la neige, ou près de l'eau, gardez la machine asec en toutes circonstances. ● Quand la génératrice est en marche: Ne jamais entourer la génératrice de cloisons ou d'écrans. Ne jamais recouvrir la génératrice d'une boîte. Ne jamais disposer d'objets sur la génératrice. |

7CF-24162-20

④

⚠ DANGER

Using a generator indoors **CAN KILL YOU IN MINUTES.**
 Generator exhaust contains carbon monoxide.
 This is a poison you cannot see or smell.

| | | |
|--|--|--|
| | | |
|--|--|--|

NEVER use inside a home or garage, **EVEN IF** doors and windows are open.

Only use **OUTSIDE** and far away from windows, door, and vents.

⑤

⚠ WARNING

Electrocution or property damage can occur : Do not connect this generator to any building's electrical system unless an isolation switch has been installed by a licensed electrician. Refer to the owner's manual.

7XF-2415A-10

⑥

| | |
|---|--|
| <p style="text-align: center;">EMISSION CONTROL INFORMATION YAMAHA MOTOR POWERED PRODUCTS CO.,LTD.</p> <p>This engine meets 20** California exhaust and evaporative emission regulations for small off-road engines. THIS ENGINE MEETS U.S. EPA EXH/EVP REGS FOR 20**.</p> <p>EMISSION COMPLIANCE PERIOD : *** HOURS EF: ***** DISPLACEMENT: *** cc EVAP F: ***** EMISSION CONTROL SYSTEM: **</p> <p>This engine is certified to operate on unleaded gasoline. ENGINE OIL: SAE***** TYPE : ** No other adjustments needed.</p> | <p style="text-align: center;">The air index of this engine is 3 (California only)</p> <div style="text-align: center;"> </div> <p style="text-align: center;">MOST CLEAN LEAST CLEAN</p> <p>Note: The lower the air index, the less the pollution. This engine is certified to be emissions compliant for the following use:</p> <p> <input type="checkbox"/> MODERATE (*** HOURS) <input checked="" type="checkbox"/> INTERMEDIATE (*** HOURS) <input type="checkbox"/> EXTENDED (*** HOURS) </p> <p style="text-align: center;">Check owner's manual for further details.</p> |
|---|--|

⑦

NOTICE

Use the specified spark plug only.

Specified plug: **BPR4ES(NGK)**

DESCRIPTION

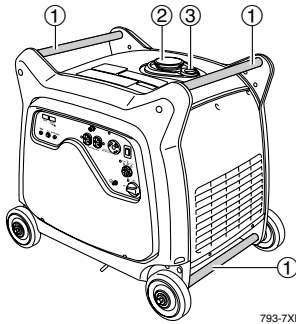

793-7XFa

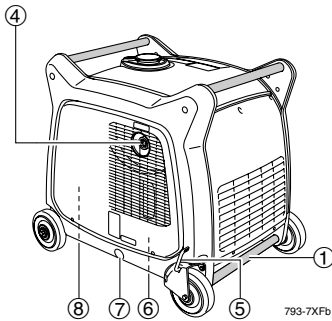

793-7XFb

Control panel

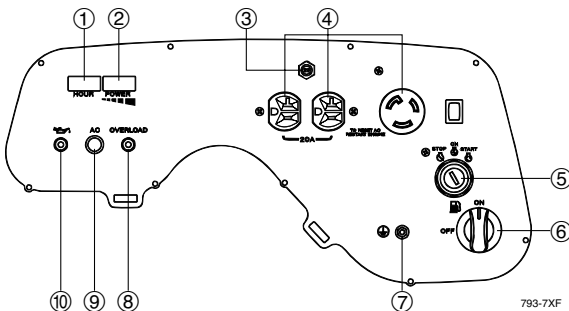

793-7XF

CONTROL FUNCTION

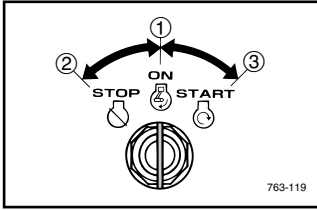

Engine switch

The engine switch controls the ignition system.

①  "ON"

Ignition circuit is switched on.

The engine can be started.

②  "STOP"

Ignition circuit is switched off.

The engine will not run.

③  "START"

Starting circuit is switched on.

The starter motor starts and the engine can be started.

After starting the engine, take your hand off the switch immediately.

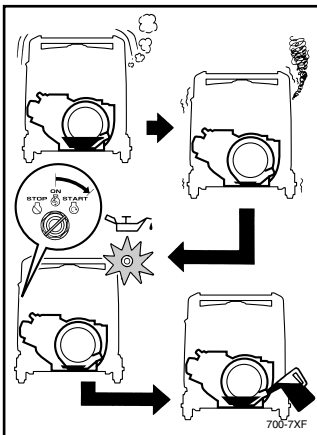

Oil warning light (red)

When the oil level falls below the lower level, the oil warning light comes on and then the engine stops automatically. Unless you refill with oil, the engine will not start again.

TIP

If the engine stalls or does not start, turn the engine switch to "START". If the oil warning light comes on, the engine oil is insufficient. Add oil and restart.

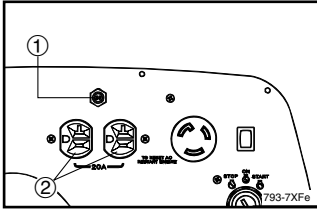

AC protector

The AC protector trips when total amount of the two AC receptacle loads exceeds 20A.



- ① AC protector
- ② AC receptacle

NOTICE

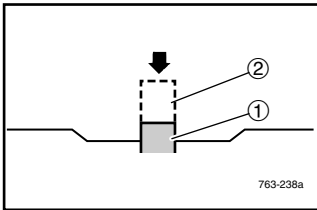
Reduce the load to within specified the generator rated output if the AC protector turns off. If the turns off again, consult a Yamaha dealer.



Press the switch to “Reset” the AC protector.

- ①  “Reset”
- ②  “OFF”

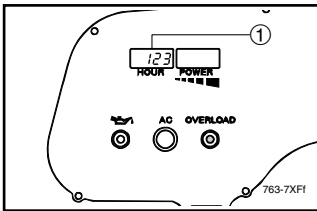

Hour meter

The hour meter shows the total number of hours the generator has been run.

- ① Hour meter

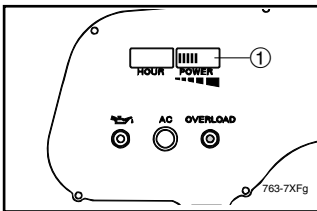

Power meter

The power meter shows the amount of electric current used by a barmeter.

The generator output is normal when the segments of the barmeter appear.

- ① Power meter

TIP

When 10 segments appear, the generator has almost reached its rated output.

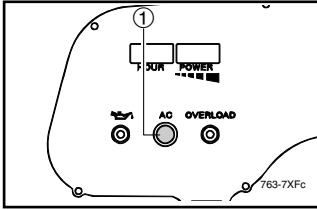

AC pilot light (green)

The AC pilot light comes on when the engine starts and produces power.

① AC pilot light

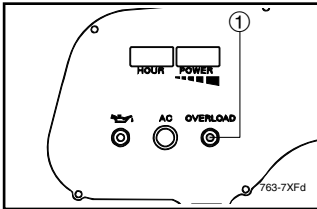

Overload indicator light (red)

The overload indicator light comes on when an overload of a connected electrical device is detected, the inverter control unit overheats, or the AC output voltage rises. Then, the AC protector will trip, stopping power generation in order to protect the generator and any connected electric devices. The AC pilot light (green) will go off and the overload indicator light (red) will stay on, but the engine will not stop running.

① Overload indicator light

When the overload indicator light comes on and power generation stops, proceed as follows:

1. Turn off any connected electric devices and stop the engine.
2. Reduce the total wattage of connected electric devices within the rated output.
3. Check for blockages in the cooling air inlet and around the control unit. If any blockages are found, remove them.
4. After checking, restart the engine.

TIP

The overload indicator light may come on for a few seconds at first when using electric devices that require a large starting current, such as a compressor or a submersible pump. However, this is not a malfunction.

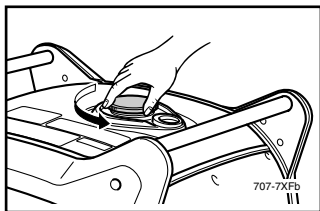

Fuel tank cap

Remove the fuel tank cap by turning it counterclockwise.

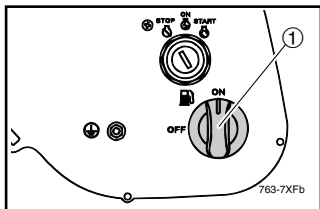

Fuel cock knob

The fuel cock supplies fuel from the fuel tank to the carburetor.

The fuel cock has two positions.

① Fuel cock knob

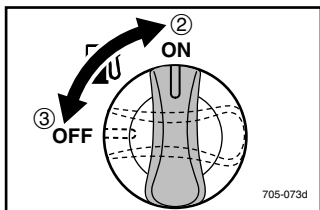

② “ON”

With the knob in this position, fuel flows to the carburetor. Normal using is done with the knob in this position.

③ “OFF”

With the knob in this position, fuel will not flow. Always turn the knob to this position when the engine is not running.

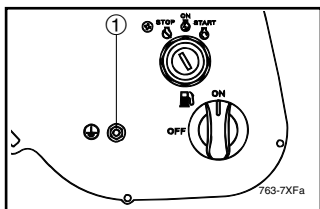

Ground (earth) terminal

Ground (earth) terminal connects the earth line for prevention of electric shock.

When the electric device is grounded, be sure to ground the generator also.

① Ground (earth) terminal

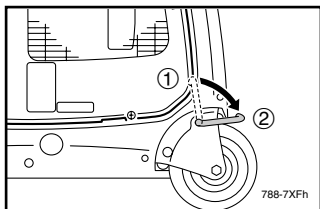

Caster lock lever

The caster lock lever stops moving the generator.

① “Release”

② “Lock”

PREPARATION

Fuel

⚠ WARNING

- Fuel is highly flammable and poisonous. Check “SAFETY INFORMATION” (See page 2) carefully before filling.
- Do not overfill the fuel tank, otherwise it may overflow when the fuel warms up and expands.
- After fill the fuel, make sure the fuel tank cap is tightened securely.

NOTICE

- Immediately wipe off spilled fuel with a clean, dry, soft cloth, since fuel may deteriorate painted surfaces or plastic parts.
- Use only unleaded gasoline. The use of leaded gasoline will cause severe damage to internal engine parts.

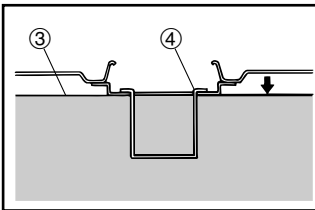
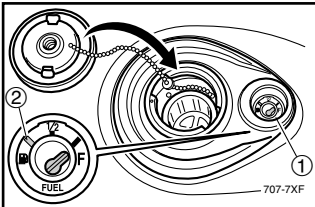
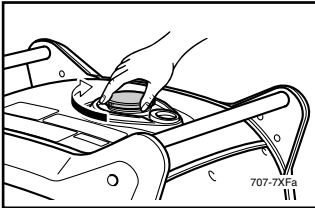
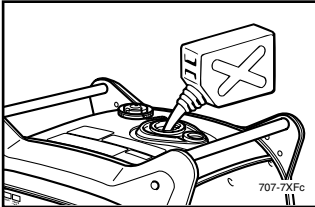
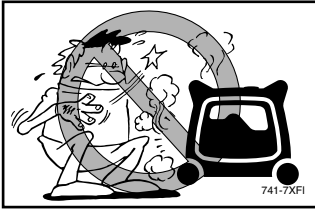

Make sure there is sufficient fuel in the tank. When refueling, be sure to fill the tank to the bottom edge of the fuel filter.

- ① Fuel level gauge
- ② Red line

| | |
|------------|-------|
| “F” | Full |
| Red line ② | Empty |

- ③ Fuel level
- ④ Fuel filter

Recommended fuel:
Unleaded gasoline
Fuel tank capacity:
Total:
17.0 L (4.49 US gal, 3.74 Imp gal)

Your Yamaha engine has been designed to use regular unleaded gasoline with a pump octane number ((R + M)/2) of 86 or higher, or research octane number of 91 or higher.

Engine oil

NOTICE

The generator has been shipped without engine oil. Do not start the engine until you have filled it with the sufficient engine oil.

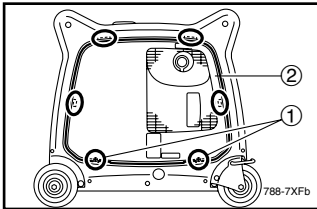

1. Place the generator on a level surface.
2. Remove the screws, and then pull outward on the areas of rear cover shown.

- ① Screws
- ② Rear cover

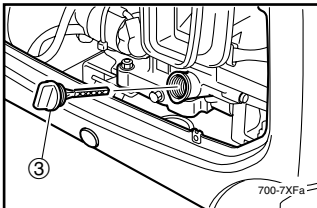

3. Remove the oil filler cap.

- ③ Oil filler cap

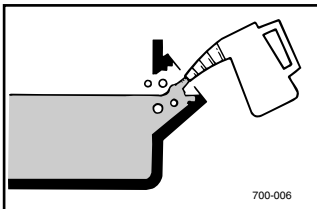

4. Fill the specified amount of the recommended engine oil, and then install and tighten the oil filler cap.

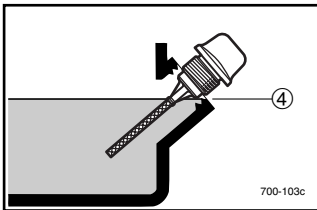

- ④ Upper level

Recommended engine oil:

- A YAMALUBE 4 (10W-40), SAE 10W-30 or 10W-40
- B SAE #30
- C SAE #20
- D SAE 10W

Recommended engine oil grade:
API Service SE type or higher

Engine oil quantity:
1.3 L (1.37 US qt, 1.14 Imp qt)

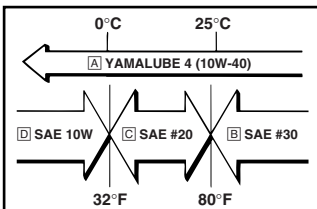

5. Install the rear cover and tighten the screws.



Battery preparation (See page 31)

⚠ WARNING

- Electrolyte is poisonous and dangerous since it contains sulfuric acid, which causes severe burns. Avoid any contact with skin, eyes or clothing and always shield your eyes when working near batteries. In case of contact, administer the following FIRST AID.
 - **EXTERNAL:** Flush with plenty of water.
 - **INTERNAL:** Drink large quantities of water or milk and immediately call a physician.
 - **EYES:** Flush with water for 15 minutes and seek prompt medical attention.
- Batteries produce explosive hydrogen gas. Therefore, keep sparks, flames, cigarettes, etc., away from the battery and provide sufficient ventilation when charging it in an enclosed space.
- **KEEP THIS AND ALL BATTERIES OUT OF THE REACH OF CHILDREN.**

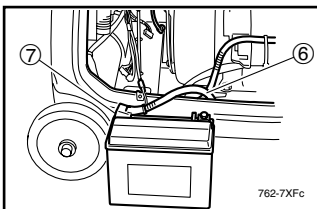
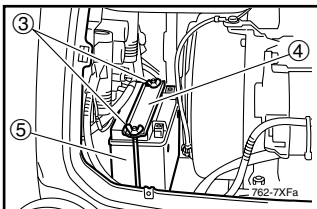
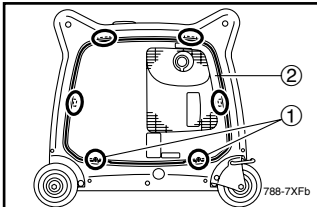

1. Remove the screws, and then pull outward on the areas of rear cover shown.

- ① Screws
- ② Rear cover

2. Remove the wing nuts and battery plate.

- ③ Wing nuts
- ④ Battery plate

3. Remove the battery.

- ⑤ Battery

4. Fill the battery with the electrolyte.

Refer to the instruction sheet included with the electrolyte for filling instructions.

5. Connect the positive lead (red) to the positive (+) battery terminal.

- ⑥ Positive lead (red)
- ⑦ Positive (+) battery terminal

6. Install the battery onto the tray.

7. Install the battery plate and tighten the wing nuts.

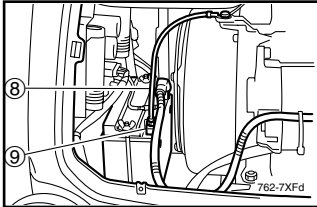

8. Connect the negative lead (black) to the negative (-) battery terminal.

⑧ Negative lead (black)

⑨ Negative (-) battery terminal

9. Install the rear cover and tighten the screws.

PRE-OPERATION CHECK

WARNING

If any item in the Pre-operation check is not working properly, have it inspected and repaired before operating the generator.

The condition of a generator is the owner's responsibility. Vital components can start to deteriorate quickly and unexpectedly, even if the generator is unused.

TIP

Pre-operation checks should be made each time the generator is used.

Pre-operation check

Fuel (See page 12)

- Check fuel level in fuel tank.
- Refuel if necessary.

Fuel line

- Check fuel hose for crack or damage.
- Replace if necessary.

Engine oil (See page 13)

- Check oil level in engine.
- If necessary, add recommended oil to specified level.
- Check generator for oil leakage.

The point where abnormality was recognized by use.

- Check operation.
- If necessary, consult a Yamaha dealer.

OPERATION

WARNING

- Never operate the engine in a closed area or it may cause unconsciousness and death within a short time. Operate the engine in a well ventilated area.
- Before starting the engine, do not connect any electric devices.
- Clean dusts, dirt or water off the receptacle before use.

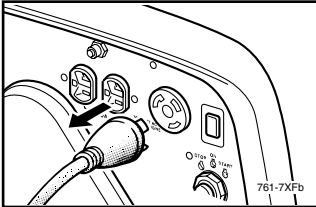

NOTICE

The generator has been shipped without engine oil. Do not start the engine until you have filled it with the sufficient engine oil.

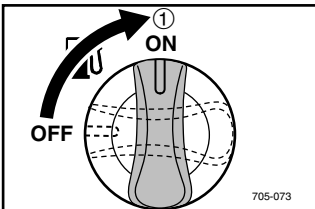

Starting the engine

1. Turn the fuel cock knob to "ON".

① "ON"

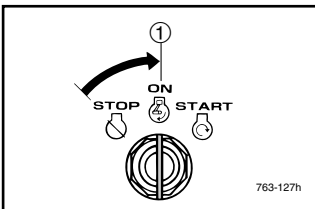

2. Turn the engine switch to "ON".

① ② "ON"

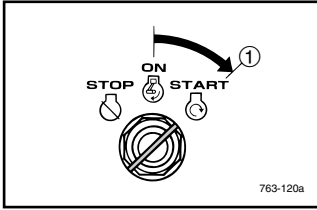

3. Turn the engine switch to “START”.
Take your hand off the switch immediately after the engine starts.

① “START”

NOTICE

If the engine fails to start, release the switch, wait a few seconds, then try again. Each attempt should be as short as possible to preserve the battery. Do not crank the engine more than 5 seconds on any one attempt.

Stopping the engine

TIP

Turn off any electric devices.

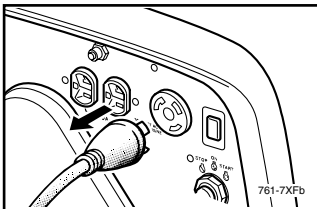

1. Disconnect any electric devices.

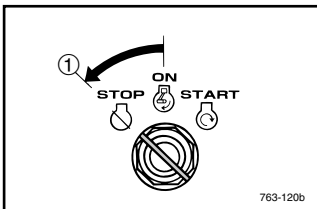

2. Turn the engine switch to “STOP”.

① “STOP”

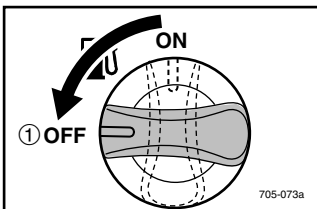

3. Turn the fuel cock knob to “OFF”.

① “OFF”

Connection Alternating Current (AC)

WARNING

Be sure any electric devices are turned off before plugging them in.

NOTICE

- Be sure all electric devices including the lines and plug connections are in good condition before connection to the generator.
- Be sure the total load is within generator rated output.
- Be sure the receptacle load current is within receptacle rated current.

TIP

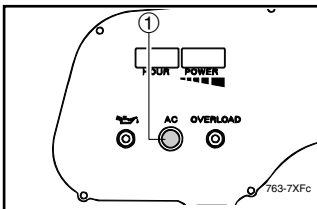
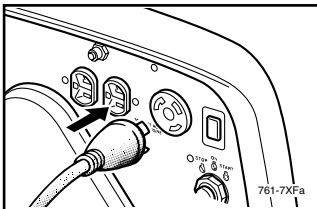

Make sure to ground (earth) the generator. When the electric device is grounded, be sure to ground the generator also.



1. Start the engine.
 2. Plug in to the AC receptacle.
 3. Make sure the AC pilot light is on.
- ① AC pilot light
4. Turn on any electric devices.

Application range

When using the generator, make sure the total load is within rated output of a generator. Otherwise, generator damage may occur.

| | | | |
|--------------|---|---|---|
| AC |  |  |  |
| Power factor | 1 | 0.8 – 0.95 | 0.4 – 0.75 (Efficiency 0.85) |
| EF4500iSE | – 4,000W | – 3,200W | – 1,360W |

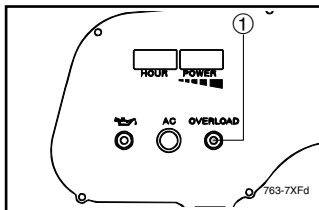

TIP

- “_” means below.
- Application wattage indicates when each device is used by itself.
- The overload indicator light comes on when total wattage exceeds the application range. (See page 10 for more details.)

① Overload indicator light

NOTICE

- **Do not overload.** The total load of all electrical appliances must not exceed the supply range of the generator. Overloading will damage the generator.
- When supplying precision equipment, electronic controllers, PCs, electronic computers, microcomputer-based equipment or battery chargers, keep the generator a sufficient distance away to prevent electrical interference from the engine. Also ensure that electrical noise from the engine does not interfere with any other electrical devices located near the generator.
- If the generator is to supply medical equipment, advice should first be obtained from the manufacturer, a medical professional or hospital.
- Some electrical appliances or general-purpose electric motors have high starting currents, and cannot therefore be used, even if they lie within the supply ranges given in the above table. Consult the equipment manufacturer for further advice.

PERIODIC MAINTENANCE

Safety is an obligation of the owner. Periodic inspection, adjustment and lubrication will keep your generator in the safest and most efficient condition possible. The most important points of generator inspection, adjustment, and lubrication are explained on the following pages.



WARNING

If you are not familiar with maintenance work, have a Yamaha dealer do it for you.

AE00403

Maintenance chart



WARNING

Stop the engine before starting maintenance work.

NOTICE

Use only Yamaha specified genuine parts for replacement. Ask an authorized Yamaha dealer for further information.

| Item | Routine | Pre-operation check | Every | |
|--------------------|--|---------------------|--------------------|---------------------|
| | | | 6 months or 100 Hr | 12 months or 300 Hr |
| Spark plug | <ul style="list-style-type: none"> • Check condition. • Clean and replace if necessary. | | ○ | |
| Fuel | <ul style="list-style-type: none"> • Check fuel level and leakage. | ○ | | |
| Fuel hose | <ul style="list-style-type: none"> • Check fuel hose for cracks or damage. • Replace if necessary. | ○ | | |
| Engine oil | <ul style="list-style-type: none"> • Check oil level in engine. | ○ | | |
| | <ul style="list-style-type: none"> • Replace. | | ○(*1) | |
| Air filter element | <ul style="list-style-type: none"> • Check condition. | | ○(*2) | |
| | <ul style="list-style-type: none"> • Clean. | | | |
| Muffler screen | <ul style="list-style-type: none"> • Check condition. • Clean and replace if necessary. | | ○ | |
| Spark arrester | <ul style="list-style-type: none"> • Check condition. • Clean and replace if necessary. | | ○ | |
| Fuel filter | <ul style="list-style-type: none"> • Clean and replace if necessary. | | | ○ |

| Item | Routine | Pre-operation check | Every | |
|--|--|---------------------|--------------------|---------------------|
| | | | 6 months or 100 Hr | 12 months or 300 Hr |
| Crankcase breather hose | <ul style="list-style-type: none"> • Check breather hose for cracks or damage. • Replace if necessary. | | | ○ |
| Cylinder head | <ul style="list-style-type: none"> • Decarbonize cylinder head. • More frequently if necessary. | | | ★ |
| Valve clearance | <ul style="list-style-type: none"> • Check and adjust when engine is cold. | | | ★ |
| Fittings / fasteners | <ul style="list-style-type: none"> • Check all fittings and fasteners. • Correct if necessary. | | | ★ |
| The point where abnormality was recognized by use. | | ○ | | |

*1..... Initial replacement of the engine oil is after one month or 20 hours of operation.

*2..... The air filter element needs to be cleaned more frequently when using in unusually wet or dusty areas.

★..... Since these items require special tools, data and technical skills, have a Yamaha dealer perform the service.

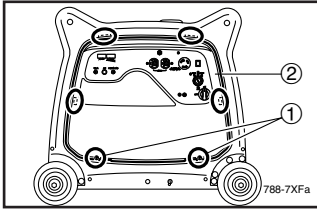

Spark plug inspection

The spark plug is an important engine component, which should be checked periodically.

1. Remove the screws, and then pull outward on the areas of front cover shown.

- ① Screws
- ② Front cover

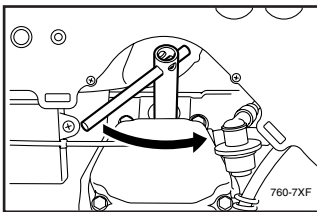

2. Remove the spark plug cap and then remove the spark plug.

3. Check for discoloration and remove the carbon. The porcelain insulator around the center electrode of spark plug should be a medium-to-light tan color.

4. Check the spark plug type and gap.

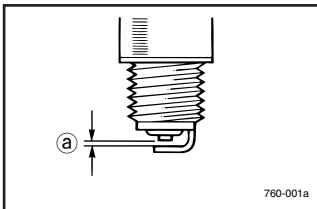

Standard spark plug:
 BPR4ES (NGK)
 Spark plug gap:
 0.7–0.8 mm (0.028–0.031 in)

- Ⓐ Gap

TIP

The spark plug gap should be measured with a wire thickness gauge and, if necessary, adjusted to specification.

5. Install the spark plug.

| |
|--|
| Spark plug torque: 20 Nm (2.0 m·kgf, 14 ft·lbf) |
|--|

TIP _____

If a torque wrench is not available when installing a spark plug, a good estimate of the correct torque is 1/4-1/2 turn past finger tight. However, the spark plug should be tightened to the specified torque as soon as possible.

6. Install the spark plug cap.
7. Install the front cover and tighten the screws.

Carburetor adjustment

The carburetor is a vital part of the engine. Adjusting should be left to a Yamaha dealer with the professional knowledge, specialized data, and equipment to do so properly.

Engine oil replacement

WARNING

Avoid draining the engine oil immediately after stopping the engine. The oil is hot and should be handled with care to avoid burns.

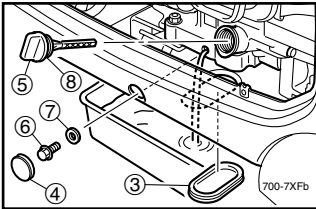
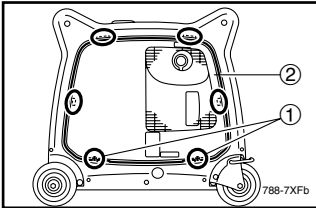

1. Place the generator on a level surface and warm up the engine for several minutes. Then stop the engine.

2. Remove the screws, and then pull outward on the areas of rear cover shown.

- ① Screws
- ② Rear cover

3. Remove the rubber cap, rubber plug and the oil filler cap.

- ③ Rubber cap
- ④ Rubber plug
- ⑤ Oil filler cap
- ⑥ Oil drain bolt
- ⑦ Gasket
- ⑧ O-ring

4. Place an oil pan under the engine. Remove the oil drain bolt so that the oil can be completely drained.

5. Check the oil drain bolt, gasket, oil filler cap and O-ring. Replace them if damaged.

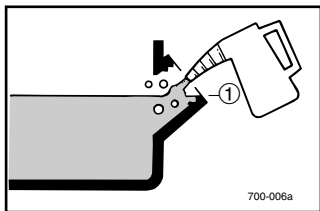

700-006a

6. Install the oil drain bolt.

Oil drain bolt torque:
30 Nm (3.0 m·kgf, 22 ft·lbf)

7. Add engine oil to the upper level.

- ① Upper level

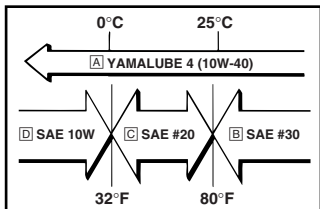

Recommended engine oil:

- Ⓐ YAMALUBE 4 (10W-40),
SAE 10W-30 or 10W-40
- Ⓑ SAE #30
- Ⓒ SAE #20
- Ⓓ SAE 10W

Recommended engine oil grade:
API Service SE type or higher

Engine oil quantity:
1.3 L (1.37 US qt, 1.14 Imp qt)

NOTICE

Be sure no foreign material enters the crankcase.

8. Install the oil filler cap, the rubber cap and the rubber plug.
9. Install the front cover and tighten the screws.

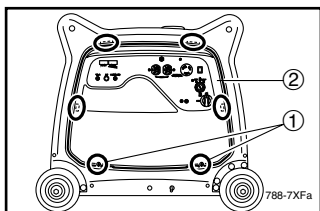

788-7XFa

Air filter

1. Remove the screws, and then pull outward on the areas of front cover shown.

- ① Screws
- ② Front cover

2. Remove the screws.

- ③ Screws

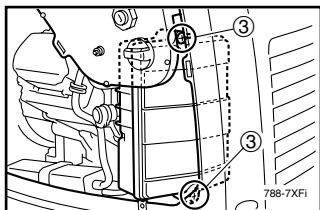

788-7XFf

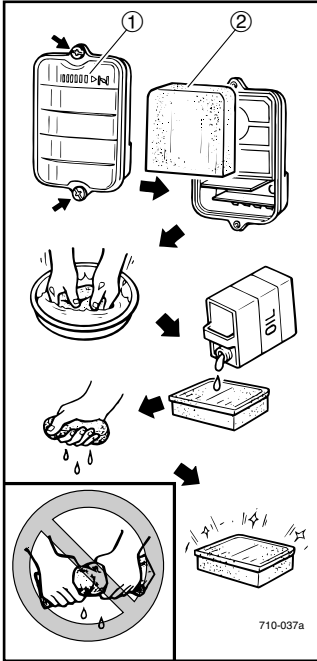

3. Remove the air filter case cover and foam element.

- ① Air filter case cover
- ② Foam element

4. Wash the foam element in solvent and dry it.

⚠ WARNING

Never use solvent while smoking or in the vicinity of an open flame.

5. Oil the foam element and squeeze out excess oil. The foam element should be wet but not dripping.

Recommended oil:
Foam-air-filter oil or SAE #20 motor oil

NOTICE

Do not wring out the foam element when squeezing it. This could cause it to tear.

6. Insert the foam element into the air filter case.

NOTICE

The engine should never run without the foam element; excessive piston and cylinder wear may result.

TIP

Be sure the foam element sealing surface matches the air filter so there is no air leak.

7. Install the air filter case cover and tighten the screws.

8. Install the front cover and tighten the screws.

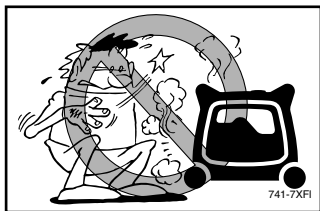

Muffler screen and spark arrester

WARNING

The engine and muffler will be very hot after the engine has been run.

Avoid touching the engine and muffler while they are still hot with any part of your body or clothing during inspection or repair.

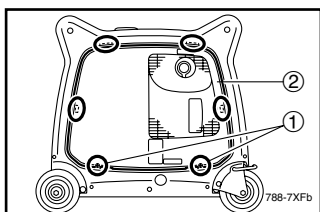

1. Remove the screws, and then pull outward on the areas of rear cover shown.

- ① Screws
- ② Rear cover

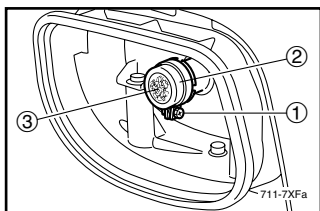

2. Loosen the bolt and then remove the muffler cap, the muffler screen and spark arrester.

- ① Bolt
- ② Muffler cap
- ③ Muffler screen
- ④ Spark arrester

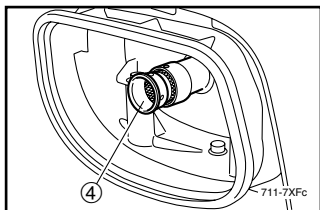
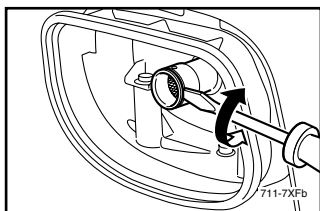

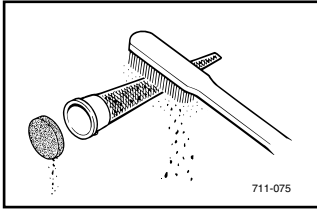

3. Remove the carbon deposits on the muffler screen and spark arrester using a wire brush.

NOTICE _____

When cleaning, use the wire brush lightly to avoid damaging or scratching of the muffler screen and spark arrester.

4. Check the muffler screen and spark arrester. Replace them if damaged.
5. Install the spark arrester.

TIP _____

Align the spark arrester lump to the hole in the muffler pipe.

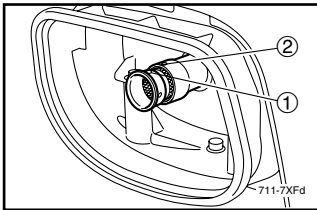

- ① Spark arrester lump
- ② Hole

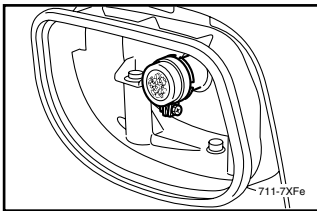

6. Install the muffler screen and the muffler cap, then tighten the bolt.
7. Install the rear cover and tighten the screws.

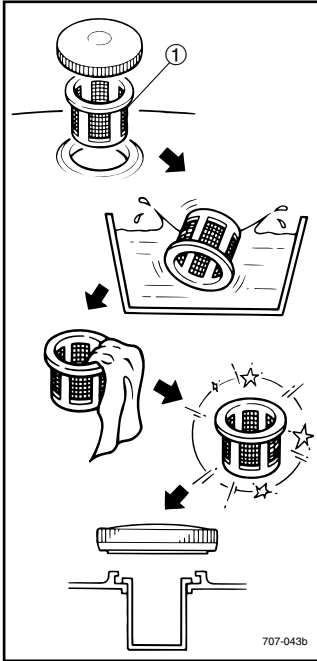

Fuel tank filter

⚠ WARNING

Never use the gasoline while smoking or in the vicinity of an open flame.

1. Remove the fuel tank cap and fuel filter.
- ① Fuel filter
2. Clean the fuel filter with gasoline.
Replace it if damaged.
3. Wipe the fuel filter and install it.
4. Install the fuel tank cap.

⚠ WARNING

Be sure the fuel tank cap is tightened securely.



Battery

This generator is equipped with a VRLA (Valve Regulated lead Acid) battery. There is no need to check the electrolyte or to add distilled water.

! WARNING

- Electrolyte is poisonous and dangerous since it contains sulfuric acid, which causes severe burns. Avoid any contact with skin, eyes or clothing and always shield your eyes when working near batteries. In case of contact, administer the following FIRST AID.
 - **EXTERNAL:** Flush with plenty of water.
 - **INTERNAL:** Drink large quantities of water or milk and immediately call a physician.
 - **EYES:** Flush with water for 15 minutes and seek prompt medical attention.
- Batteries produce explosive hydrogen gas. Therefore, keep sparks, flames, cigarettes, etc., away from the battery and provide sufficient ventilation when charging it in an enclosed space.
- **KEEP THIS AND ALL BATTERIES OUT OF THE REACH OF CHILDREN.**

To charge the battery

Have a Yamaha dealer charge the battery as soon as possible if it seems to have discharged.

NOTICE

To charge a VRLA battery, a special (constant-voltage) battery charger is required. Using a conventional battery charger will damage the battery. If you do not have access to a constant-voltage battery charger, have a Yamaha dealer charge your battery.

Recommended battery

Recommended battery:
Capacity: 12V/18Ah

Fuse replacement

WARNING

Be sure to use specified fuse. A wrong fuse will cause electrical system damage and A FIRE HAZARD.

NOTICE

Be sure the engine switch is turned to “STOP” to prevent accidental short circuiting.

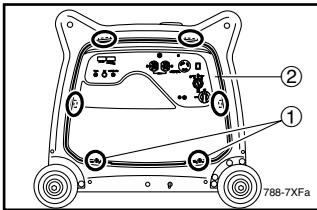

1. Remove the screws, and then pull outward on the areas of front cover shown.

- ① Screws
- ② Front cover

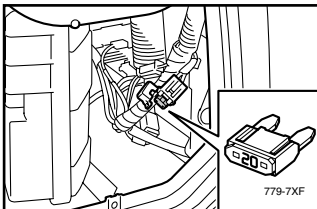

2. Replace the fuse with one of proper amperage.

Specified fuse: 20A

TIP

If the fuse immediately blows again, consult a Yamaha dealer.

3. Install the front cover and tighten the screws.

STORAGE

Long term storage of your generator will require some preventive procedures to guard against deterioration.

Drain the fuel

1. Turn the engine switch to "STOP".

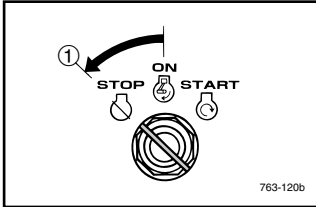

- ① "STOP"

2. Remove the fuel tank cap. Extract the fuel from the fuel tank into an approved gasoline container using a commercially available handsiphon. Then, install the fuel tank cap.

! WARNING

Fuel is highly flammable and poisonous. Check "SAFETY INFORMATION" (See page 2) carefully.

NOTICE

Immediately wipe off spilled fuel with a clean, dry, soft cloth, since fuel may deteriorate painted surfaces or plastic parts.

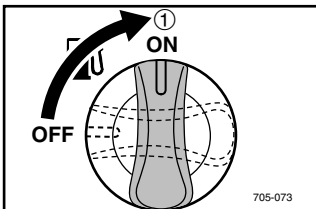

3. Turn the fuel cock knob to "ON".

- ① "ON"

4. Start the engine and leave it run until it stops. The engine stops in approximately 20 minutes time by running out of fuel.

TIP

- Do not connect with any electrical devices. (unloaded operation)
- Duration of the running engine depends on the amount of the fuel left in the tank.

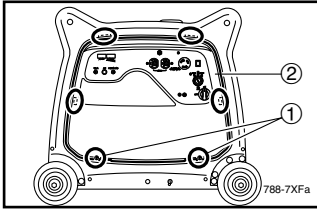

5. Remove the screws, and then pull outward on the areas of front cover shown.

- ① Screws
- ② Front cover

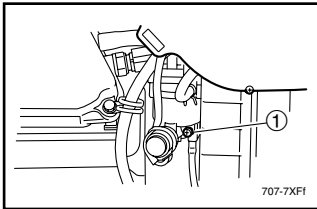

6. Drain the fuel remaining in the carburetor into an approved container by loosening the drain screw on the carburetor float chamber.

- ① Drain screw

7. Tighten the drain screw.

8. Turn the engine switch to "OFF".

9. Turn the fuel cock knob to "OFF".

10. Install the cover and tighten the screws.



11. Tighten further if any screws, bolts and nuts are loose.

12. Store the generator in a dry, well-ventilated place, with the cover placed over it.



Engine

Perform the following steps to protect the cylinder, piston ring, etc. from corrosion.

1. Remove the spark plug cap and spark plug, pour about one tablespoon of SAE 10W-30 or 20W-40 motor oil into spark plug hole and reinstall the spark plug only.
2. Turn the engine switch to “START” and crank the engine several seconds with ignition off to coat the cylinder walls with oil.
3. Clean exterior of the generator and apply a rust inhibitor.
4. Store the generator in a dry, well-ventilated place, with the cover placed over it.
5. The generator must remain in a vertical position when stored, carried or operated.
6. The caster lock lever should be in the “Lock” when stored or operated.

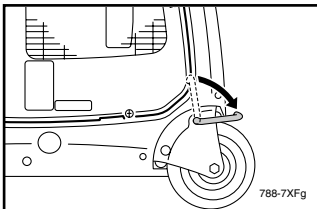

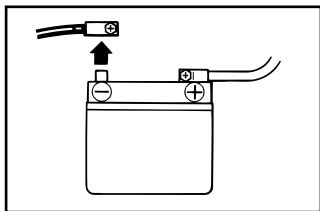

Battery

1. Remove the battery.
2. Store the battery in a cool, dark and dry place and charge it once a month.

Do not store the battery in an excessive cold or warm place [i.e., less than 0°C (30°F) or more than 30°C (90°F)].

WARNING

- **Disconnect the negative lead (black) first, then the positive lead (red) from the battery.**
- **Connect the positive lead (red) first, then the negative lead (black) to the battery when installing the battery.**

— MEMO —

TROUBLESHOOTING

Engine won't start

1. Fuel systems

No fuel supplied to combustion chamber.

- No fuel in tank Supply fuel.
- Fuel in tank Fuel cock knob to "ON".

① "ON"

- Clogged fuel line Clean fuel line.
- Clogged carburetor Clean carburetor.

2. Engine oil system

Insufficient

- Oil level is low Add engine oil.

3. Electrical systems

- Engine switch to "START".

① "START"

Poor spark

- Spark plug dirty with carbon or wet Remove carbon or wipe spark plug dry.
- Faulty ignition system Consult a Yamaha dealer.

Generator won't produce power

- Safety device (AC protector) to "OFF" Press the AC protector to "Reset".

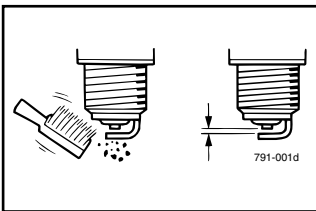
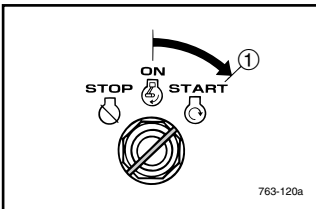
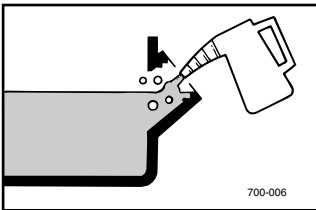
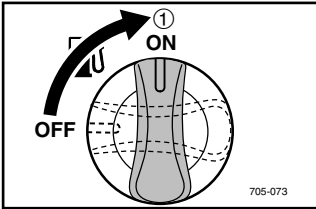
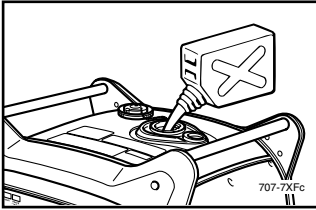

A ENGINE DOES NOT START



B Turn the engine switch to "ON", then turn the engine switch to "START". And check if the starter motor cranks.

| | |
|----------|------------------|
| C Cranks | D Does not crank |
|----------|------------------|



F Turn the engine switch to "START", and check if the oil warning light comes on.

| | |
|--------------------|------------|
| G Does not come on | H Comes on |
|--------------------|------------|



L Turn the engine switch to "START" and check the spark plug for spark strength. (See "WARNING").

⚠ WARNING

- To prevent **FIRE HAZARDS** be sure fuel is not present in the spark plug area.
- To prevent **FIRE HAZARDS** be sure to place the spark plug as far away as possible from the spark plug hole and carburetor area.
- To prevent **ELECTRIC SHOCK** do not hold spark plug lead with hand while testing.

| | |
|------|-------------------|
| M OK | N Does not spark. |
|------|-------------------|



R Check the following

- Fuel cock clogging
- Air cleaner element clogging.

| | |
|---|---------|
| S | Clogged |
| T | OK |

| | |
|--------------------------|------|
| U Clean or replace | V OK |
| W Engine does not start. | |



X Consult a Yamaha dealer.

E Faulty battery and/or starter motor.
Consult a Yamaha dealer.

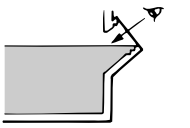
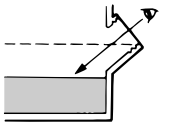
| | |
|--|---|
| I Check engine oil level. | |
|  |  |
| J OK | K Level low |
| Consult a Yamaha dealer. | Add engine oil. |

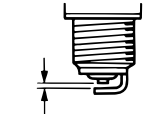
| | |
|--|---|
| O Check the spark plug. | |
| <ul style="list-style-type: none"> • Type: BPR4ES • Gap: 0.7–0.8 (0.028–0.031) mm (in) | |
|  |  |
| P Incorrect | Q OK |
| Replace or adjust gap. | Clean the spark plug. |

SPECIFICATIONS

Dimensions

| | Unit | EF4500iSE |
|----------------|---------|------------|
| Overall Length | mm (in) | 780 (30.7) |
| Overall Width | mm (in) | 616 (24.3) |
| Overall Height | mm (in) | 692 (27.2) |
| Dry Weight | kg (lb) | 88 (194) |

Engine

| | Unit | EF4500iSE |
|----------------------|---------------------|------------------------------------|
| Type | | Air cooled 4-stroke gasoline OHV |
| Cylinder Arrangement | | Inclined, 1 cylinder |
| Displacement | cm ³ | 357 |
| Bore × Stroke | mm (in) | 85.0 × 63.0 (3.35 × 2.48) |
| Operation Hours | Hr | 7.4 – 15.2 (rated load – 1/4 load) |
| Fuel | | Unleaded gasoline |
| Fuel Tank Capacity | L (US gal, Imp gal) | 17.0 (4.49, 3.74) |
| Engine Oil Quantity | L (US qt, Imp qt) | 1.3 (1.37, 1.14) |
| Ignition System | | TCI |
| Spark Plug: Type | | BPR4ES (NGK) |
| Gap | mm (in) | 0.7 – 0.8 (0.028 – 0.031) |
| Noise Level* | dB/LWA | 89.5 |
| | dB (A)/7m | 65 – 68 |

* : Noise level is measured when the economy control switch is turned to “ON”.

LWA shows the sound power level under the ISO3744 satisfied test conditions.

The noise level in “dB (A) / 7 m” is the arithmetic mean value in four directions measured 7 meters away from each side of the generator.

The noise level may vary in different environments.

Generator

| | Unit | EF4500iSE |
|---------------------|------|-------------------------------------|
| AC Output | | |
| Rated voltage | V | 120 |
| Rated frequency | Hz | 60 |
| Rated current | A | 33.3 |
| Rated output | kVA | 4.0 |
| Safety Device: Type | | Electronic and Mechanical (bimetal) |

Battery

| | Unit | EF4500iSE |
|----------|------|-----------|
| Voltage | V | 12 |
| Capacity | Ah | 18 |

CONSUMER INFORMATION

PRI-I.D. NUMBER:

| | | |
|----------------------|----------------------|----------------------|
| | MODEL | |
| | <input type="text"/> | |
| PRI-I.D. CODE | | SERIAL No. |
| <input type="text"/> | | <input type="text"/> |

Identification number records

Record your Primary I.D., and serial numbers in the spaces provided, to assist you in ordering spare parts from a Yamaha dealer.

Also record and keep these I.D. numbers in a separate place in case your machine is stolen.

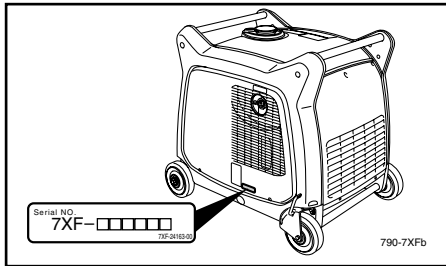

Machine identification

The machine serial number is stamped in the location as shown.

TIP

The first three digits of these numbers are for model identification; the remaining digits are the unit production number. Keep a record of these numbers for reference when ordering parts from a Yamaha dealer.

EXHAUST EMISSION CONTROL SYSTEM AND COMPONENTS

| Item | Acronym |
|--|---|
| • CARB. ASSY., LH. & JT.,CARBURETOR2 | CARB (Carburetor) |
| • T.C.I. MAGNETO ASSY. &PLUG, SPARK | EI (Electronic Ignition) |
| • CRANKCASE1 & HEAD,CYLINDER1 | PCV (Positive Crankcase Ventilation) |
| • AIR FILTER ASSY. | ACL (Air Cleaner) |
| • MUFF., 2, CAP, NET, WIRE2 & ARRESTER, SPARK | |

The above items and the corresponding acronyms are provided in accordance with U.S. EPA REGULATIONS FOR NEW NONROAD SPARK-IGNITION NONHANDHELD ENGINES and the CALIFORNIA REGULATIONS FOR 1995 AND LATER SMALL OFF-ROAD ENGINES.

The acronyms conform to the latest version of the SAE's recommended practice document J1930, "Diagnostic Acronyms, Terms, and Definitions For Electrical/Electronic System".

It is recommended that these items be serviced by a Yamaha dealer.

— MEMO —

WIRING DIAGRAM

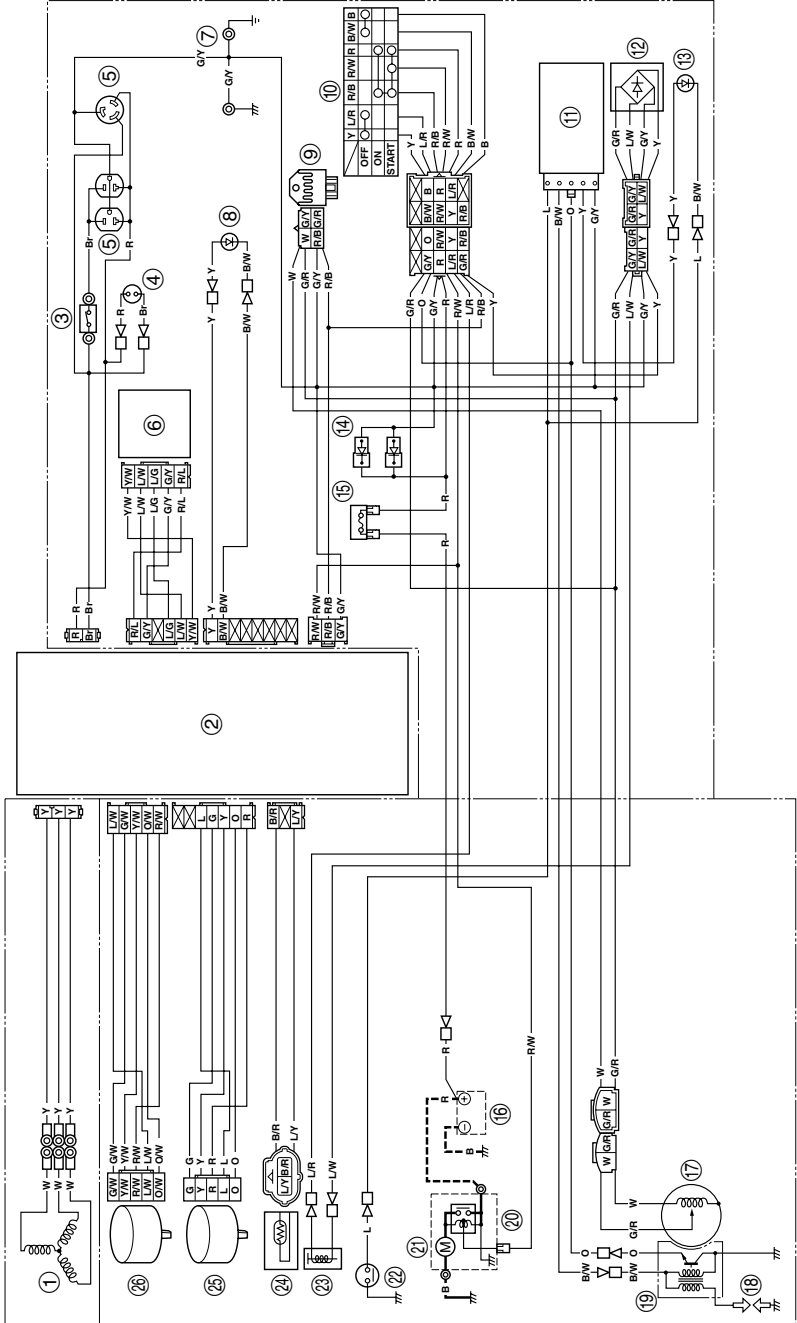

| | Color code |
|----------------------------|-------------------|
| ① Main coil | B |
| ② Control unit | Black |
| ③ AC protector | Br |
| ④ AC pilot light | Green |
| ⑤ AC receptacle | L |
| ⑥ Hour meter/power meter | O |
| ⑦ Ground (earth) terminal | R |
| ⑧ Overload indicator light | White |
| ⑨ Rectifier/regulator | Y |
| ⑩ Engine switch | Yellow |
| ⑪ Speed limiter assembly | Yellow/White |
| ⑫ Rectifier | B/R |
| ⑬ Oil warning light | Black/Red |
| ⑭ Diode assembly | B/W |
| ⑮ Fuse | Black/White |
| ⑯ Battery | G/R |
| ⑰ T.C.i. magneto | Green/Red |
| ⑱ Spark plug | G/W |
| ⑲ T.C.i. unit | Green/White |
| ⑳ Starter relay | G/Y |
| ㉑ Starter motor | Green/Yellow |
| ㉒ Oil level gauge | L/G |
| ㉓ Fuel cut solenoid valve | Blue/Green |
| ㉔ Thermo sensor | L/R |
| ㉕ Throttle motor | Blue/Red |
| ㉖ Auto choke | L/W |
| | Blue/White |
| | L/Y |
| | Blue/Yellow |
| | O/W |
| | Orange/White |
| | R/B |
| | Red/Black |
| | R/L |
| | Red/Blue |
| | R/W |
| | Red/White |

YAMAHA MOTOR CORPORATION, U.S.A.
EF SERIES GENERATORS
3-YEAR LIMITED WARRANTY

Yamaha Motor Corporation, U.S.A. hereby warrants that new Yamaha generators purchased from an authorized Yamaha generator dealer in the United States will be free from defects in material and workmanship for the period of time stated herein, subject to certain stated limitations.

THE PERIOD OF WARRANTY Any new EF-series Yamaha generator purchased from an authorized Yamaha generator dealer in the United States will be warranted against defects in material or workmanship for a period of three (3) years from date of purchase for pleasure or (except EF1000iS) commercial use, subject to exclusions noted herein. Yamaha EF1000iS generators purchased for commercial use from an authorized Yamaha generator dealer in the continental United States will be warranted against defects in materials or workmanship for a period of two (2) years from the date of purchase, subject to exclusions noted herein.

DURING THE PERIOD OF WARRANTY any authorized Yamaha generator service dealer will, free of charge, repair or replace, at Yamaha's option, any part judged defective by Yamaha due to faulty workmanship or material from the factory. Parts used in warranty repairs will be warranted for the balance of the product's warranty period. All parts replaced under warranty become the property of Yamaha Motor Corporation, U.S.A.

GENERAL EXCLUSIONS from this warranty shall include any failures caused by:

- a. Installation of parts or accessories that are not qualitatively equivalent to genuine Yamaha parts.
- b. Abnormal strain, neglect, or abuse.
- c. Lack of proper maintenance.
- d. Accident or collision damage.

SPECIFIC EXCLUSIONS from this warranty shall include parts replaced due to normal wear or routine maintenance.

THE CUSTOMER'S RESPONSIBILITY under this warranty shall be to:

1. Operate and maintain the generator as specified in the appropriate Owner's Manual.
2. Give notice to an authorized Yamaha consumer generator service dealer of any and all apparent defects within ten (10) days after dis-

covery, and make the machine available at that time for inspection and repairs at such dealer's place of business. You may locate your nearest authorized Yamaha generator service dealer online at www.yamaha-motor.com.

EMISSION CONTROL SYSTEM WARRANTY

Yamaha Motor Corporation, U.S.A. also warrants to the ultimate purchaser and each subsequent purchaser of each 1995 and later Yamaha Generator covered by this warranty that the product is designed, built, and equipped so as to conform at the time of sale with all U.S. emissions standards applicable at the time of manufacture and that it is free from defects in materials and workmanship which would cause it not to meet these standards within the period listed immediately below. Failures other than those resulting from defects in material or workmanship which arise solely as a result of owner abuse and/or lack of proper maintenance are not covered by this warranty.

All 1995 and Later EF Models

Two (2) years from the original purchase date

WARRANTY TRANSFER: To transfer any remaining warranty from the original purchaser to any subsequent purchaser, it is imperative that the unit be inspected and registered for warranty by an authorized Yamaha consumer generator dealer. In order for this warranty to remain in effect, this inspection and registration must take place within ten (10) days after transfer. A reasonable dealer imposed fee may be charged for the inspection.

YAMAHA MOTOR CORPORATION, U.S.A. MAKES NO OTHER WARRANTY OF ANY KIND, EXPRESSED OR IMPLIED. ALL IMPLIED WARRANTIES OF MERCHANTABILITY AND FITNESS FOR A PARTICULAR PURPOSE WHICH EXCEED THE OBLIGATIONS AND TIME LIMITS STATED IN THIS WARRANTY ARE HEREBY DISCLAIMED BY YAMAHA MOTOR CORPORATION, U.S.A. AND EXCLUDED FROM THIS WARRANTY.

SOME STATES DO NOT ALLOW LIMITATIONS ON HOW LONG AN IMPLIED WARRANTY LASTS, SO THE ABOVE LIMITATIONS MAY NOT APPLY TO YOU. ALSO EXCLUDED FROM THIS WARRANTY ARE ANY INCIDENTAL OR CONSEQUENTIAL

DAMAGES INCLUDING LOSS OF USE. SOME STATES DO NOT ALLOW THE EXCLUSION OR LIMITATION OF INCIDENTAL OR CONSEQUENTIAL DAMAGES, SO THE ABOVE EXCLUSION MAY NOT APPLY TO YOU.

THIS WARRANTY GIVES YOU SPECIFIC LEGAL RIGHTS, AND YOU MAY ALSO HAVE OTHER RIGHTS WHICH VARY FROM STATE TO STATE.

YAMAHA MOTOR CORPORATION, U.S.A.
Post Office Box 6555
Cypress, California 90630

WARRANTY QUESTIONS AND ANSWERS

Q. What costs are my responsibility during the warranty period?

A. The customer's responsibility includes all costs of normal maintenance service, non-warranty repairs, accident damages, as well as oil and spark plugs.

Q. What are some examples of "abnormal" strain, neglect, or abuse?

A. These terms are general and overlap each other in areas. Specific examples include: Running the machine out of oil; lack of proper maintenance; operating the machine with a broken or damaged part which causes another part to fail; and so on. If you have any specific questions on operation or maintenance, please contact your dealer for advice.

Q. Does the warranty cover incidental costs such as transportation due to a failure?

A. No. The warranty is limited to repair of the machine itself.

Q. May I perform any or all of the recommended maintenance shown in the Owner's Manual instead of having the dealer do them?

A. Yes, if you are a qualified mechanic and follow the procedures specified in the Owner's and Service Manual. We do recommend, however, that items requiring special tools or equipment be done by a Yamaha generator dealer.

Q. Will the warranty be void or cancelled if I do not operate or maintain my new Yamaha exactly as specified in the Owner's Manual?

A. No. The warranty on a new Yamaha cannot be "voided" or "cancelled."

However, if a particular failure is caused by operation or maintenance other than as shown in the Owner's Manual, that failure may not be covered under warranty.

Q. What responsibility does my dealer have under this warranty?

A. Each Yamaha generator dealer is expected to:

1. Check the operation of the generator before sale.
2. Explain the operation, maintenance, and warranty requirements to your satisfaction at the time of sale, and upon your request at any later date.

In addition, each Yamaha generator dealer is held responsible for his setup, service and warranty repair work.

Q. Is the warranty transferable to second owners?

A. Yes. The remainder of the existing warranty can be transferred upon request.

The unit has to be inspected and reregistered by an authorized Yamaha generator dealer for the policy to remain effective.

CUSTOMER SERVICE

If your machine requires warranty service, you must take it to any authorized Yamaha generator dealer within the continental United States. Be sure to bring your warranty registration identification or other valid proof of the original date of purchase. If a question or problem arises regarding warranty, first contact the owner of the dealership. Since all warranty matters are handled at the dealer level, this person is in the best position to help you. If you are still not satisfied and require additional assistance, please write:

YAMAHA MOTOR CORPORATION U.S.A.
CUSTOMER RELATIONS DEPARTMENT
P.O. BOX 6555
Cypress, California 90630

CHANGE OF ADDRESS

The federal government requires each manufacturer to maintain a complete, up-to-date list of all first purchasers against the possibility of a safety-related defect and recall. This list is compiled from the purchase registrations sent to Yamaha Motor Corporation, U.S.A. by the selling dealer at the time of your purchase. If you should move after you have purchased your new generator, please advise us of your new address by sending a postcard listing your Yamaha model name, engine number, dealer number (or dealer's name) as it is shown on your warranty identification, your name and new mailing address. Mail to:

YAMAHA MOTOR CORPORATION, U.S.A.
WARRANTY DEPARTMENT
P.O. Box 6555
Cypress, California 90630

This will ensure that Yamaha Motor Corporation, U.S.A. has an up-to-date registration record in accordance with federal law.

**YAMAHA OUTDOOR POWER EQUIPMENT
CALIFORNIA EVAPORATIVE EMISSION CONTROL WARRANTY STATEMENT
YOUR WARRANTY RIGHTS AND OBLIGATIONS**

The California Air Resources Board and Yamaha Motor Corporation, USA are pleased to explain the evaporative emission control system's warranty on your 2006 or later outdoor power equipment. In California, new equipment that use small off-road engines must be designed, built, and equipped to meet the State's stringent anti-smog standards. Yamaha Motor Corporation, USA must warrant the evaporative emission control system on your outdoor power equipment for the period listed below provided there has been no abuse, neglect, or improper maintenance of your equipment.

Your evaporative emission control system may include parts such as: carburetors, fuel tanks, fuel lines, fuel caps, valves, canisters, filters, vapor hoses, clamps, connectors, and other associated components. For engines less than or equal to 80cc, only the fuel tank is subject to the evaporative emission control warranty requirements of this section.

**MANUFACTURER'S
WARRANTY COVERAGE:**

This evaporative emission control system is warranted for two years. If any evaporative emission-related part on your equipment is defective, the part will be repaired or replaced by Yamaha.

**OWNER'S
WARRANTY RESPONSIBILITIES:**

- As the outdoor power equipment owner, you are responsible for the performance of the required maintenance listed in your owner's manual. Yamaha recommends that you retain all receipts covering maintenance of your outdoor power equipment, but Yamaha cannot deny warranty solely for the lack of receipts.
- As the outdoor power equipment owner, you should however be aware that Yamaha may deny you warranty coverage if your outdoor power equipment or a part has failed due to abuse, neglect, or improper maintenance, or unapproved modifications.
- You are responsible for presenting your outdoor power equipment to a Yamaha service center as soon as the problem exists. The warranty repairs should be completed in a reasonable amount of time, not to exceed 30 days.

If you have a question regarding your warranty coverage, you should contact Yamaha Customer Relations at 1-800-962-7926.

YAMAHA MOTOR CORPORATION, USA
Post Office Box 6555
Cypress, California 90630

**YAMAHA MOTOR CORPORATION, U.S.A.
SMALL OFF ROAD ENGINES
CALIFORNIA EMISSION CONTROL WARRANTY
YOUR WARRANTY RIGHTS AND OBLIGATIONS**

The California Air Resources Board and Yamaha Motor Corporation, U.S.A. are pleased to explain the emission control system warranty on your 2008 and later Small Off Road Engine (SORE). In California, new SORE engines must be designed, built and equipped to meet the State's stringent anti-smog standards. Yamaha must warrant the emission control system on your SORE engine for the periods of time listed below provided there has been no abuse, neglect or improper maintenance of your SORE engine.

Your emission control system may include parts such as the carburetor or fuel-injection system, the ignition system, and catalytic converter. Also included may be hoses, belts, connectors and other emission-related assemblies.

Where a warrantable condition exists, Yamaha will repair your SORE engine at no cost to you including diagnosis, parts and labor.

MANUFACTURER'S WARRANTY COVERAGE

The 2008 and later SORE engines are warranted for two years. If any emissions-related part on your engine is defective, the part will be repaired or replaced by Yamaha.

OWNER'S WARRANTY RESPONSIBILITIES

- As the SORE engine owner, you are responsible for the performance of the required maintenance listed in your owner's manual. Yamaha recommends that you retain all receipts covering maintenance on your SORE engine, but Yamaha cannot deny warranty solely for the lack of receipts or for your failure to ensure the performance of all scheduled maintenance.
- As the SORE engine owner, you should however be aware that Yamaha may deny you warranty coverage if your SORE engine or a part has failed due to abuse, neglect, improper maintenance or unapproved modifications.
- You are responsible for presenting your SORE engine to a Yamaha dealer as soon as a problem exists. The warranty repairs should be completed in a reasonable time, not to exceed 30 days.

If you have any questions regarding your warranty rights and responsibilities, you should contact the Yamaha Customer Relations Department at 1-800-962-7926.

Yamaha Motor Corporation, U.S.A. warrants to the ultimate purchaser and each subsequent purchaser thereafter that each new SORE engine certified for sale and registered in California are:

1. Designed, built, and equipped so as to conform, at the time of sale, with all applicable regulations adopted by the California Air Resources Board, and
2. All warranted parts are free from defects in material and workmanship for the warranty period of the SORE engine or the period prior to the first scheduled replacement point of the warranted part as required by the maintenance schedule, if applicable, whichever is less. A defect exists when a deficiency in material or workmanship is such that an emission-related warranted part does not function as designed.

The warranty period begins on the date that the SORE engine is delivered to an ultimate purchaser or on the date it is first placed in service.

The warranty on emissions-related parts will be interpreted as follows:

- (1) Any warranted part that is not scheduled for replacement as required maintenance in the written

instructions required by subsection (d) must be warranted for the warranty period defined in Subsection (b)(2). If any such part fails during the period of warranty coverage, it must be repaired or replaced by the manufacturer according to Subsection (4) below. Any such part repaired or replaced under the warranty must be warranted for the remaining warranty period.

- (2) Any warranted part that is scheduled only for regular inspection in the written instructions required by subsection (d) must be warranted for the warranty period defined in Subsection (b)(2). A statement in such written instructions to the effect of "repair or replace as necessary" will not reduce the period of warranty coverage. Any such part repaired or replaced under warranty must be warranted for the remaining warranty period.
- (3) Any warranted part that is scheduled for replacement as required maintenance in the written instructions required by subsection (d) must be warranted for the period of time prior to the first scheduled replacement point for that part. If the part fails prior to the first scheduled replacement, the part must be repaired or replaced by the engine manufacturer according to Subsection (4) below. Any such part repaired or replaced under warranty must be warranted for the remainder of the period prior to the first scheduled replacement point for the part.
- (4) Repair or replacement of any warranted part under the warranty must be performed at no charge to the owner at a warranty station.
- (5) Notwithstanding the provisions of Subsection (4) above, warranty services or repairs must be provided at all manufacturer distribution centers that are franchised to service the subject engines.
- (6) The owner must not be charged for diagnostic labor that leads to the determination that a warranted part is in fact defective, provided that such diagnostic work is performed at a warranty station.
- (7) The manufacturer is liable for damages to other engine components proximately caused by a failure under warranty of any warranted part.
- (8) Throughout the emissions warranty period defined in Subsection (b)(2), the manufacturer must maintain a supply of warranted parts sufficient to meet the expected demand for such parts.
- (9) Any replacement part may be used in the performance of any warranty maintenance or repairs and must be provided without charge to the owner. Such use will not reduce the warranty obligations of the manufacturer.
- (10) Add-on or modified parts that are not exempted by the Air Resources Board may not be used. The use of any non-exempted add-on or modified parts will be grounds for disallowing a warranty claim. The manufacturer will not be liable to warrant failures of warranted parts caused by the use of a non-exempted add-on or modified part.
- (11) The manufacturer issuing the warranty shall provide any documents that describe that manufacturer's warranty procedures or policies within five working days of request by the Air Resources Board.

WARRANTED PARTS INCLUDE the following:

1. Fuel Metering System
Carburetor and internal parts (or fuel injection system)
Air/fuel ratio feedback and control system
Cold start enrichment system
2. Air Induction system
Controlled hot air intake system
Intake manifold
Air filter
3. Ignition System
Spark plugs*
Magneto or electronic ignition system
Spark advance/retard system
4. Exhaust Gas Recirculation (EGR) System
EGR valve body, and carburetor spacer if applicable
EGR rate feedback and control system

5. Air Injection System
Air pump or pulse valve
Valves affecting distribution of flow
Distribution manifold
6. Catalyst or Thermal Reactor System
Catalytic converter
Thermal reactor
Exhaust manifold
7. Particulate Controls
Traps, filters, precipitators, and any other device
used to capture particulate emissions
8. Miscellaneous Items Used in Above Systems
Vacuum, temperature, and time sensitive
valves and switches
Electronic controls
Hoses, belts, connectors, and assemblies
9. Engine components damaged due to a failure under warranty or a warranted part

*The original spark plug(s) are warranted for the period of replacement indicated in the Owner's Manual and not the useful life of the SORE engine (see your Owner's Manual).

DURING THE PERIOD OF THIS WARRANTY

Yamaha Motor Corporation, U.S.A. will repair or replace any warranted part deemed defective by Yamaha during the scope of the warranty without charge to the owner, including parts, labor, and diagnosis. This work must be done at an authorized Yamaha dealer. Give notice to an authorized Yamaha dealer of any apparent defects(s) within a reasonable period of time after discovery. The SORE engine must be made available for inspection by an authorized Yamaha dealer.

OWNER'S RESPONSIBILITY:

The owner of the SORE engine is responsible for the performance of required maintenance (see your Owner's Manual). Receipts and maintenance records covering the performance of regular maintenance should be retained in the event questions arise concerning maintenance. The receipts should be transferred to each subsequent owner of this SORE engine.

The emission control systems of your Yamaha SORE engine were designed, built, tested, and certified as being in conformity with California emission control regulations using genuine Yamaha parts. Accordingly, it is recommended that any replacement part(s) used for maintenance, replacement, or repair of emission control systems be Yamaha parts. The owner may elect to have maintenance, replacement, or repair of the emission control devices and systems performed by any repair establishment or individual, and may elect to use parts other than Yamaha parts for such maintenance, replacement, or repair without invalidating this warranty. However, the cost of such service or parts will not be covered under the warranty.

EXCLUSIONS: No warranty coverage will be allowed if the part(s) failure was caused by owner/operator abuse, neglect, tampering, improper adjustment unless performed by a dealer during warranty repair work, modification, misuse, alteration, or improper maintenance (see your Owner's Manual).

Use of parts which are not qualitatively equivalent to genuine Yamaha parts, improper service, or lack of required maintenance which causes failure of a warranted part may constitute abuse and/or improper service, thereby invalidating warranty liability hereunder.

This warranty does not cover damage resulting from accidents, acts of nature, or other events or occurrences beyond the control of Yamaha. Yamaha Motor Corporation, U.S.A. expressly disclaims responsibility for any and all consequential damages, such as loss of time, inconvenience, loss or use of the SORE engine, or commercial loss.

YAMAHA MOTOR CORPORATION, U.S.A.
Post Office Box 6555
Cypress, California 90630

YAMAHA EXTENDED SERVICE (Y.E.S.)

Keep your Yamaha Generator protected even after your warranty expires with genuine Yamaha Extended Service (Y.E.S.).

- Y.E.S. is designed and administered by Yamaha Motor Corporation to provide maximum owner satisfaction. You get uninterrupted factory-backed coverage for extra peace of mind.
- Y.E.S. is flexible. You can choose the plan that's right for you: 12 months, 24 months or 36 months coverage.
- Y.E.S. is administered by the same Yamaha people that handle your warranty - and it shows in the comprehensive coverage benefits. There are no hour limitations and Y.E.S. covers manufacturing defects just like your warranty. See a sample contract at your Yamaha dealer and see how comforting uninterrupted factory backed protection can be.
- There are no "out-of-pocket" expenses for covered repairs. Yamaha will never ask you to pay a deductible.
- Nationwide coverage. Y.E.S. coverage is honored at any authorized Yamaha Outdoor Power Equipment Service dealer.
- Y.E.S. coverage is transferable to a new owner if you sell or trade-in. That can make you Yamaha much more valuable.

This excellent Y.E.S. plan coverage is only available to Yamaha owners like you, and only while your Yamaha is still within the Yamaha Limited Warranty period. So visit your authorized Yamaha dealer to get all the facts. He can show you how easy it is to protect your investment with Yamaha Extended Service.

Special note:

If visiting your dealer isn't convenient, contact Yamaha with your Primary ID number (your frame number). We'll be happy to help you get the Y.E.S. coverage you need.

Yamaha Service Marketing
P.O. Box 6555
Cypress, CA 90630
1-866-YES-EXTD
(1-866-937-3983)

— MEMO —

— MEMO —



PRINTED ON RECYCLED PAPER

PRINTED IN JAPAN
2011.04-0.2x1 
(E)

Register Your Generator at
www.yamahawarrantyregistration.com
Or complete the card below and Mail

Generator Warranty Registration

To begin your 3 year warranty coverage, please register online within 30 days of purchase:

www.yamahawarrantyregistration.com

If you prefer, you can complete and mail this card. Be sure to attach proper postage.

Owner's Name _____
Address _____
City _____ State _____ Zip _____
Phone Number (_____) _____ - _____
E-mail address _____

Yamaha Generator Model Name: _____ (Example) EF2000IS

Yamaha Generator Primary I.D. Serial Number: -
(See "Machine Identification" in your Owner's Manual for location of this number)
(The green stamp is not the valid Primary ID Serial Number)

(Example) 7DK - 0000000

Date Purchased _____ / _____ / _____ Selling Dealer Name _____
Month Day Year

- Please register online or complete and mail this form. It will help ensure that Yamaha has accurately registered your purchase for warranty.
- Manufacturers are required to maintain a complete up-to-date list of all first purchasers of products in the event of a safety-related defect or recall.

**PLACE
STAMP
HERE**

**YAMAHA MOTOR CORPORATION U.S.A.
P.O. BOX 6555
CYPRESS, CA 90630
ATTN: WARRANTY DEPARTMENT**