

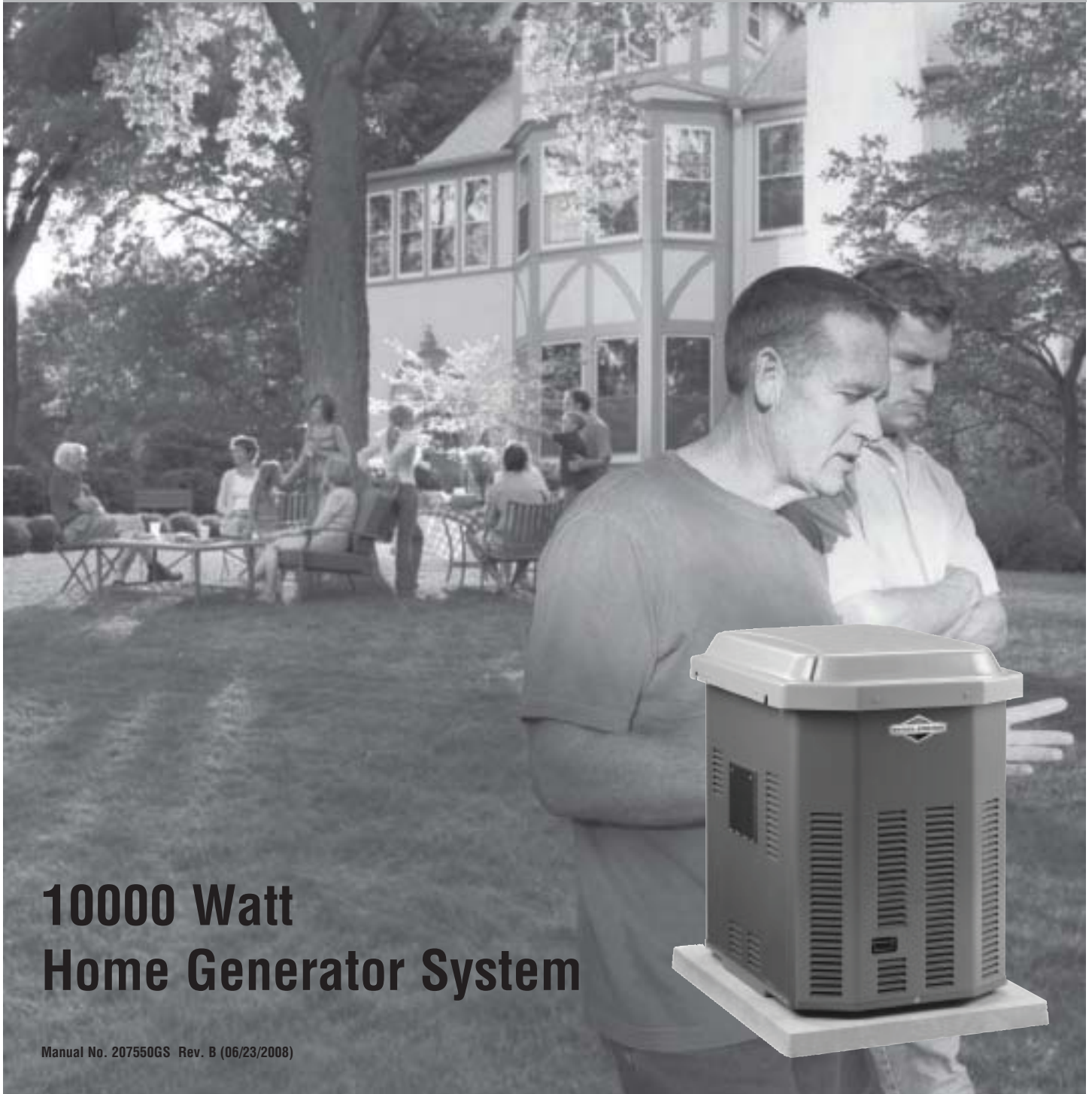

Home Generator Systems

Operator's Manual



10000 Watt Home Generator System

Manual No. 207550GS Rev. B (06/23/2008)

Thank you for purchasing this quality-built Briggs & Stratton home generator. We're pleased that you've placed your confidence in the Briggs & Stratton brand. When operated and maintained according to the instructions in this manual, your Briggs & Stratton home generator will provide many years of dependable service.

This manual contains safety information to make you aware of the hazards and risks associated with home generator systems and how to avoid them. This home generator system is designed and intended only for use as an optional home standby system that provides an alternate source of electric power and to serve loads such as heating, refrigeration systems, and communication systems that, when stopped during any power outage, could cause discomfort or inconvenience. This product is not intended for any other purpose and does not qualify for emergency standby as defined by NFPA 70 (NEC).

This home generator requires professional installation before use. Refer to the separate Installation Manual for full information. Follow the instructions completely. **Save these instructions for future reference.**

Where to Find Us

You never have to look far to find Briggs & Stratton support and service for your generator. Consult your Yellow Pages. There are thousands of Briggs & Stratton authorized service dealers worldwide who provide quality service. You can also contact Briggs & Stratton Customer Service by phone at **(800) 743-4115**, or use the Service Center Locator at BRIGGSandSTRATTON.COM, which provides a list of Briggs & Stratton Authorized Dealers.

Date of Purchase

Generator

Model Number

Model Revision

Serial Number

Engine

Model Number

Briggs & Stratton Power Products Group, LLC
900 North Parkway
Jefferson, WI 53549

Copyright © 2008 Briggs & Stratton Power Products Group, LLC.
All rights reserved. No part of this material may be reproduced or transmitted in any form by any means without the express written permission of Briggs & Stratton Power Products Group, LLC.

Table of Contents

Important Safety Instructions	4
Hazard Symbols and Meanings	4
Installation	7
For the Home Owner:	7
For the Installing Dealer/Contractor:	7
Owner Orientation	7
Fuel Factors	7
Generator Location.	8
Essential Circuits	8
Delivery Inspection.	9
Features and Controls	10
Home Generator	10
System Control Panel.	11
Access Covers	12
Operation	12
Important Owner's Considerations.	12
Automatic Operation	12
Setting Exercise Timer.	13
Maintenance	13
Servicing the System	13
Fault Detection System	13
Generator Maintenance	15
Engine Oil.	15
Battery	16
When Calling the Factory	17
Storage.	17
Troubleshooting	19
Schematic	20
Wiring Diagram	21
Warranty	22
Product Specifications	24

Safety

Installation

Controls

Operation

Maintenance

Troubleshooting

Warranty

Save These Instructions









Important Safety Instructions



The safety alert symbol (▲) is used with a signal word (DANGER, CAUTION, WARNING), a pictorial and/or a safety message to alert you to hazards. **DANGER** indicates a hazard which, if not avoided, will result in death or serious injury. **WARNING** indicates a hazard which, if not avoided, could result in death or serious injury. **CAUTION** indicates a hazard which, if not avoided, might result in minor or moderate injury. **NOTICE** indicates a situation that could result in equipment damage. Follow safety messages to avoid or reduce the risk of injury or death.

The manufacturer cannot possibly anticipate every possible circumstance that might involve a hazard. The warnings in this manual, and the tags and decals affixed to the unit are, therefore, not all-inclusive. If you use a procedure, work method or operating technique that the manufacturer does not specifically recommend, you must satisfy yourself that it is safe for you and others. You must also make sure that the procedure, work method or operating technique that you choose does not render the generator system unsafe.

NOTE: Your generator is equipped with a spark arrester muffler. The spark arrester must be maintained in effective working order by the owner/operator. In the State of California, a spark arrester is required by law (Section 4442 of the California Public Resources Code). Other states may have similar laws. Federal laws apply on federal lands.

Hazard Symbols and Meanings



		
Explosion	Fire	Electrical Shock
		
Toxic Fumes	Rotating Parts	Hot Surface
		
Auto Start	Explosive Pressure	Chemical Burn



▲ WARNING	
	Storage batteries give off explosive hydrogen gas during recharging. Slightest spark will ignite hydrogen and cause explosion.
	Battery electrolyte fluid contains acid and is extremely caustic.
	Contact with battery contents will cause severe chemical burns.
A battery presents a risk of electrical shock and high short circuit current.	
<ul style="list-style-type: none"> • DO NOT dispose of battery in a fire. • DO NOT allow any open flame, spark, heat, or lit cigarette during and for several minutes after charging a battery. • DO NOT open or mutilate the battery. • Wear protective goggles, rubber apron, and rubber gloves. • Remove watches, rings, or other metal objects. • Use tools with insulated handles. 	



▲ WARNING	
	Running engine gives off carbon monoxide, an odorless, colorless, poison gas. Breathing carbon monoxide can cause headache, fatigue, dizziness, vomiting, confusion, seizures, nausea, fainting or death.
<ul style="list-style-type: none"> • Operate generator ONLY outdoors. • Install a battery operated carbon monoxide alarm near the bedrooms. • Keep exhaust gas from entering a confined area through windows, doors, ventilation intakes, or other openings. 	

▲ WARNING	
The engine exhaust from this product contains chemicals known to the State of California to cause cancer, birth defects, or other reproductive harm.	

▲ WARNING	
Certain components in this product and related accessories contain chemicals known to the State of California to cause cancer, birth defects, or other reproductive harm. Wash hands after handling.	

 WARNING	
	<p>Generator produces hazardous voltage. Failure to properly ground generator can result in electrocution. Failure to isolate generator from power utility can result in death or injury to electric utility workers due to backfeed of electrical energy.</p>
<ul style="list-style-type: none"> • When using generator for backup power, notify utility company. • DO NOT touch bare wires or receptacles. • DO NOT use generator with electrical cords which are worn, frayed, bare or otherwise damaged. • DO NOT handle generator or electrical cords while standing in water, while barefoot, or while hands or feet are wet. • If you must work around a unit while it is operating, stand on an insulated dry surface to reduce shock hazard. • DO NOT allow unqualified persons or children to operate or service generator. • In case of an accident caused by electrical shock, immediately shut down the source of electrical power and contact the local authorities. Avoid direct contact with the victim. • Despite the safe design of the home generator, operating this equipment imprudently, neglecting its maintenance or being careless can cause possible injury or death. • Remain alert at all times while working on this equipment. Never work on the equipment when you are physically or mentally fatigued. • Before performing any maintenance on the generator, disconnect the battery cable indicated by a NEGATIVE, NEG or (-) first. When finished, reconnect that cable last. • After your home generator is installed, the generator may crank and start without warning any time there is a power failure. To prevent possible injury, always set the generator's system switch to OFF, remove the service disconnect from the disconnect box AND remove the 15 Amp fuse BEFORE working on the equipment. 	

 WARNING	
 	<p>Propane and Natural Gas are extremely flammable and explosive. Fire or explosion can cause severe burns or death.</p>
<ul style="list-style-type: none"> • Install the fuel supply system according to applicable fuel-gas codes. • Before placing the home generator into service, the fuel system lines must be properly purged and leak tested. • After the generator is installed, you should inspect the fuel system periodically. • NO leakage is permitted. • DO NOT operate engine if smell of fuel is present or other explosive conditions exist. • DO NOT smoke around the generator. Wipe up any oil spills immediately. Ensure that no combustible materials are left in the generator compartment. Keep the area near the generator clean and free of debris. 	

 WARNING	
 	<p>Contact with muffler area can result in serious burns. Exhaust heat/gases can ignite combustibles or structures causing a fire.</p>
<ul style="list-style-type: none"> • DO NOT touch hot parts and AVOID hot exhaust gases. • Allow equipment to cool before touching. • DO NOT install the generator closer than 5 feet (1.5m) from any combustibles or structures with combustible walls having a fire resistance rating of less than 1 hour. • Keep at least minimum distances shown in <i>General Location Guidelines</i> to insure for proper generator cooling and maintenance clearances. • Code of Federal Regulation (CFR) Title 36 Parks, Forests, and Public Property require equipment powered by an internal combustion engine to have a spark arrester, maintained in effective working order, complying to USDA Forest service standard 5100-1C or later revision. In the State of California a spark arrester is required under section 4442 of the California Public resources code. Other states may have similar laws. 	

⚠ WARNING



Starter and other rotating parts can entangle hands, hair, clothing, or accessories.

- NEVER operate generator without protective housing or covers.
- DO NOT wear loose clothing, jewelry or anything that may be caught in the starter or other rotating parts.
- Tie up long hair and remove jewelry.

⚠ CAUTION



Installing the 15A fuse could cause the engine to start.

- Observe that the 15 Amp fuse has been removed from the control panel for shipping.
- DO NOT install this fuse until all plumbing and wiring has been completed and inspected.

⚠ CAUTION

Excessively high operating speeds increase risk of injury and damage to generator.

Excessively low speeds impose a heavy load.

- DO NOT tamper with governed speed. Generator supplies correct rated frequency and voltage when running at governed speed.
- DO NOT modify generator in any way.

NOTICE

Exceeding generators wattage/amperage capacity can damage generator and/or electrical devices connected to it.

- See *Essential Circuits*.
- Start generator and let engine stabilize before connecting electrical loads.

NOTICE

Improper treatment of generator can damage it and shorten its life.

- Use generator only for intended uses.
- If you have questions about intended use, ask dealer or contact Briggs & Stratton.
- Operate generator only on level surfaces.
- Adequate, unobstructed flow of cooling and ventilating air is critical to correct generator operation.
- The Oil Fill, Oil Drain and the Control Panel doors must be installed whenever the unit is running.
- DO NOT expose generator to excessive moisture, dust, dirt, or corrosive vapors.
- Despite the safe design of the home generator, operating this equipment imprudently, neglecting its maintenance or being careless can cause possible injury or death.
- Remain alert at all times while working on this equipment. NEVER work on the equipment when you are physically or mentally fatigued.
- DO NOT start engine with air cleaner or air cleaner cover removed.
- DO NOT insert any objects through cooling slots.
- DO NOT use the generator or any of its parts as a step. Stepping on the unit can cause stress and break parts. This may result in dangerous operating conditions from leaking exhaust gases, fuel leakage, oil leakage, etc.
- If connected devices overheat, turn them off and disconnect them from generator.
- Shut off generator if:
 - electrical output is lost;
 - equipment sparks, smokes, or emits flames;
 - unit vibrates excessively.

Installation

We sincerely appreciate your patronage. For this reason, Briggs & Stratton has made every effort to provide for a safe, streamlined and cost-effective installation. Because each installation is unique, it is impossible to know of and advise the trade of all conceivable procedures and methods by which installation might be achieved. Neither could we know of possible hazards and/or the results of each method or procedure. For these reasons,

Only current licensed electrical and plumbing contractors should attempt home generator system installations. Installations must strictly comply with all applicable codes, industry standards and regulations.

Your Briggs & Stratton home generator is supplied with this "Operator's Manual" and a separate "Installation Manual". These are important documents and should be retained by the owner after the installation has been completed.

For the Home Owner:

To help you make informed choices and communicate effectively with your installation contractor(s),

Read and understand *Owner Orientation* in this manual before contracting or starting your home generator installation.

To arrange for proper installation, contact the store at which you purchased your Briggs & Stratton home generator, your dealer, a licensed electrician or your utility power provider.

The home generator warranty is VOID unless the system is installed by licensed electrical and plumbing professionals.

The Emission Control System for this generator is warranted for standards set by the U.S. Environmental Protection Agency and by the California Air Resources Board (CARB).

For the Installing Dealer/Contractor:

For most applications, the Installation manual contains all the information required to properly install and start the home generator. This Operator's Manual describes essential circuit selection, routine operation and owner maintenance procedures.

If you need more information, call **(800) 743-4115**, between 8:00 AM and 5:00 PM CT.

Owner Orientation

This section provides home generator owners with the information necessary to achieve the most satisfactory and cost effective installation possible.

The illustrations are for typical circumstances and are meant to familiarize you with the installation options available with your home generator. A thorough understanding of these options will provide fundamental control over the cost of your installation, as well as ensure your final satisfaction and security.

Federal and local codes, appearance, noise levels, fuel types, and distances are the factors that must be considered when negotiating with an installation professional. Remember that as the distance from the existing electrical service and gaseous fuel supply increases, and the number of 90 degree bends in the fuel supply increases; equal compensations in piping and wiring materials must be allowed for. This is necessary to comply with local codes and overcome electrical voltage drops and gaseous fuel pressure drops.



The factors mentioned above will have a direct affect on the overall price of your home generator installation.

NOTE: In some areas you may need to acquire electrical permits for installing the home generator, building permits for installing gas lines, and permits for noise allowances. Your installer should check your local codes AND obtain the permits before installing the system.

Fuel Factors

An important consideration affecting the entire installation is the type of fuel used by your home generator. The system was factory tested and adjusted using either natural gas or liquid propane (LP vapor). For proper engine function, factors that are inherent to each of these fuels, your location and the duration of possible utility interruptions are important considerations in the following fuel guidelines:

- Use clean, dry fuel, free of moisture or any particulate material. Using fuels outside the following recommended values may cause performance problems.
- In engines set up to run on propane (LP), commercial grade HD5 propane with a minimum fuel energy of 2500 BTUs/ft³ with maximum propylene content of 5% and butane and heavier gas content of 2.5% and minimum propane content of 90%.

 WARNING	
	Propane and Natural Gas are extremely flammable and explosive.
	Fire or explosion can cause severe burns or death.
<ul style="list-style-type: none"> • The home generator is equipped with an automatic safety gas "fuel shut-off" valve. • DO NOT operate the equipment if the "fuel shut-off" valve is missing or inoperative. 	

Power Decrease at High Altitude or High Temperature

Air density is less at high altitudes, resulting in less available engine power. Specifically, engine power will decrease 3.5% for each 1,000 feet (300 meters) above sea level and 1% for each 10° F (5.6°C) above 77°F (25°C). Make sure you and your installer consider these factors when determining total generator load.

Generator Location



The actual physical location of your home generator has a direct affect on:

1. The amount of plumbing required to fuel your generator.
2. The amount of wiring required to control and connect your generator.

NOTE: Specific location guidelines are discussed in the Installation Manual. Acquaint yourself with that information and confer with your installer. Be sure to ask how your site might affect installation costs and compliance with local codes and standards.

Generator Clearances

The generator must be installed outdoors. DO NOT install generator where exhaust gas could accumulate and enter inside or be drawn into a potentially occupied building. Ensure exhaust gas is kept away from any windows, doors, ventilation intakes or other openings that can allow exhaust gas to collect in a confined area. Prevailing winds and air currents should be taken into consideration when positioning generator. See the Installation Manual for full details on safe generator location.

 WARNING	
	Exhaust heat/gases can ignite combustibles or structures causing a fire.
<ul style="list-style-type: none"> • DO NOT install the generator closer than 5 feet (1.5m) from any combustibles or structures with combustible walls having a fire resistance rating of less than 1 hour. • Keep at least minimum distances shown in <i>General Location Guidelines</i> in <i>Installation Manual</i> to insure for proper generator cooling and maintenance clearances. 	

Essential Circuits

As a home generator owner, it is important that you clearly identify the circuits in your building that are “essential” to you.

It is also important that your installer understand **which** circuits you want to include as “Essential Circuits”. Depending on the power consumed by these circuits, most or all of them can be switched to the home generator for the duration of normal power interruption.

The wattage reference table that follows will assist you with your decision-making process. It provides the wattage used by many ordinary household devices. Use it as a guide when selecting your essential circuits. Review this information with your installer and ask about any technical considerations that might affect your installation. This chart serves as a guide only. For exact wattage use an appropriate wattage meter

	Device	Running Watts
<input type="checkbox"/>	Air Conditioner (12,000 Btu)*	1700
<input type="checkbox"/>	Air Conditioner (24,000 Btu)*	3800
<input type="checkbox"/>	Air Conditioner (40,000 Btu)*	6000
<input type="checkbox"/>	Battery Charger (20 Amp)	500
<input type="checkbox"/>	Circular Saw (6-1/2")	800 to 1000
<input type="checkbox"/>	Clothes Dryer (Electric)*	5750
<input type="checkbox"/>	Clothes Dryer (Gas)*	700
<input type="checkbox"/>	Clothes Washer*	1150
<input type="checkbox"/>	Coffee Maker	1750
<input type="checkbox"/>	Compressor (1 HP)*	2000
<input type="checkbox"/>	Compressor (1/2 HP)*	1400
<input type="checkbox"/>	Compressor (3/4 HP)*	1800
<input type="checkbox"/>	Curling Iron	700
<input type="checkbox"/>	Dehumidifier*	650
<input type="checkbox"/>	Electric Blanket	400
<input type="checkbox"/>	Electric Range (per element)	1500
<input type="checkbox"/>	Electric Skillet	1250
<input type="checkbox"/>	Freezer*	700
<input type="checkbox"/>	Furnace Fan (1/2 HP)*	800
<input type="checkbox"/>	Garage Door Opener*	500 to 750
<input type="checkbox"/>	Hair Dryer	1200
<input type="checkbox"/>	Hand Drill	250 to 1100
<input type="checkbox"/>	Iron	1200
<input type="checkbox"/>	Jet Pump*	800
<input type="checkbox"/>	Light Bulb	100
<input type="checkbox"/>	Microwave Oven	700 to 1000
<input type="checkbox"/>	Milk Cooler*	1100
<input type="checkbox"/>	Oil Burner on Furnace	300
<input type="checkbox"/>	Oil Fired Space Heater (140,000 Btu)	400
<input type="checkbox"/>	Oil Fired Space Heater (30,000 Btu)	150
<input type="checkbox"/>	Oil Fired Space Heater (85,000 Btu)	225
<input type="checkbox"/>	Radio	50 to 200
<input type="checkbox"/>	Refrigerator	700
<input type="checkbox"/>	Slow Cooker	200
<input type="checkbox"/>	Submersible Pump (1 HP)*	2000
<input type="checkbox"/>	Submersible Pump (1/2 HP)*	1500
<input type="checkbox"/>	Submersible Pump (1-1/2 HP)*	2800
<input type="checkbox"/>	Sump Pump*	800 to 1050
<input type="checkbox"/>	Table Saw (10")*	1750 to 2000
<input type="checkbox"/>	Television	200 to 500
<input type="checkbox"/>	Toaster	1000 to 1650
*Allow three (3) times listed watts for starting device		

Essential Circuit Selection

When selecting the essential circuits that will be switched to “Standby Power,” it is important that the sum of the combined circuit loads does not exceed the wattage/ amperage capacity of the generator. To help you with your selection of essential circuits, please consider the following:

- Add up the total wattage of all electrical devices to be connected at one time. This total should **NOT** be greater than the generator’s wattage capacity.

The rated wattage of lights can be taken from light bulbs. The rated wattage of tools, appliances and motors can usually be found on a data plate or decal affixed to the device.

- If the appliance, tool or motor nameplate does not list wattage, multiply volts times the ampere rating to determine watts (**Volts x Amps = Watts**).

Some electric motors (induction types) require about three times more watts of power for starting than for running. This surge lasts for only a few seconds. Be sure you allow for this high starting wattage when selecting electrical devices that will be energized by the home generator:

- Figure the watts required to start the largest motor.
- Add that to the total running watts of all other connected loads.

This Briggs & Stratton home generator complies with the following “stationary standby power rating”:

The standby power rating is applicable for supplying power for the duration of normal power interruption. No sustained overload capability is available for this rating.

This rating is applicable to installations served by a reliable normal utility source. This rating is only applicable to variable loads with an average load factor of 80% of the standby rating. The standby rating is only applicable for optional standby power where the generator set serves as the backup to the normal utility source.

Use the wattage reference table provided and mark those circuits you consider “critical” or “essential”. Make sure you and your installer consider the system’s altitude above sea level and the ambient temperature range when determining total generator load.

IMPORTANT: When using the 100 Amp or 200 Amp transfer switch with the home generator, you must turn off any non essential loads. Failure to turn off non essential loads could overload the generator causing it to shut down.

Some examples of non essential loads are as follows:

- Pool pump
- Hot tub
- Electric hot tub and/or pool heaters
- Central air conditioners
- Electric hot water heaters
- Electric range and/or oven
- Arc welder
- Non essential electric heaters

Delivery Inspection

Carefully inspect the home generator for any damage that may have occurred during shipment.

IMPORTANT: If loss or damage is noted at time of delivery, have the person(s) making delivery note all damage on the freight bill and affix his signature under the consignor’s memo of loss or damage. If loss or damage is noted after delivery, separate the damaged materials and contact the carrier and your installer for claim procedures. Missing or damaged parts are not warranted.

The home generator is supplied with:

- Home generator
- Pre-attached mounting pad
- One flexible hook-up hose (meets UL 569 and CSA 8.3)
- Installation and Start-up manual
- Operator’s manual
- Installation checklist
- Touch up paint
- Oil drain tray
- Roof hardware bag
- One spare 15A fuse
- 2 Pole connector (for 240V from house)
- 10 Pole connector (for sensing and control wires)
- Remote LED Indicator kit (red LED/plate/screws)

Required Items Supplied by Installer

- Battery

Features and Controls

Home Generator



Read this Operator's Manual and Safety Rules before operating your generator.

Compare the illustrations with your generator to familiarize yourself with the locations of various controls and adjustments. **Save this manual for future reference.**

Controls

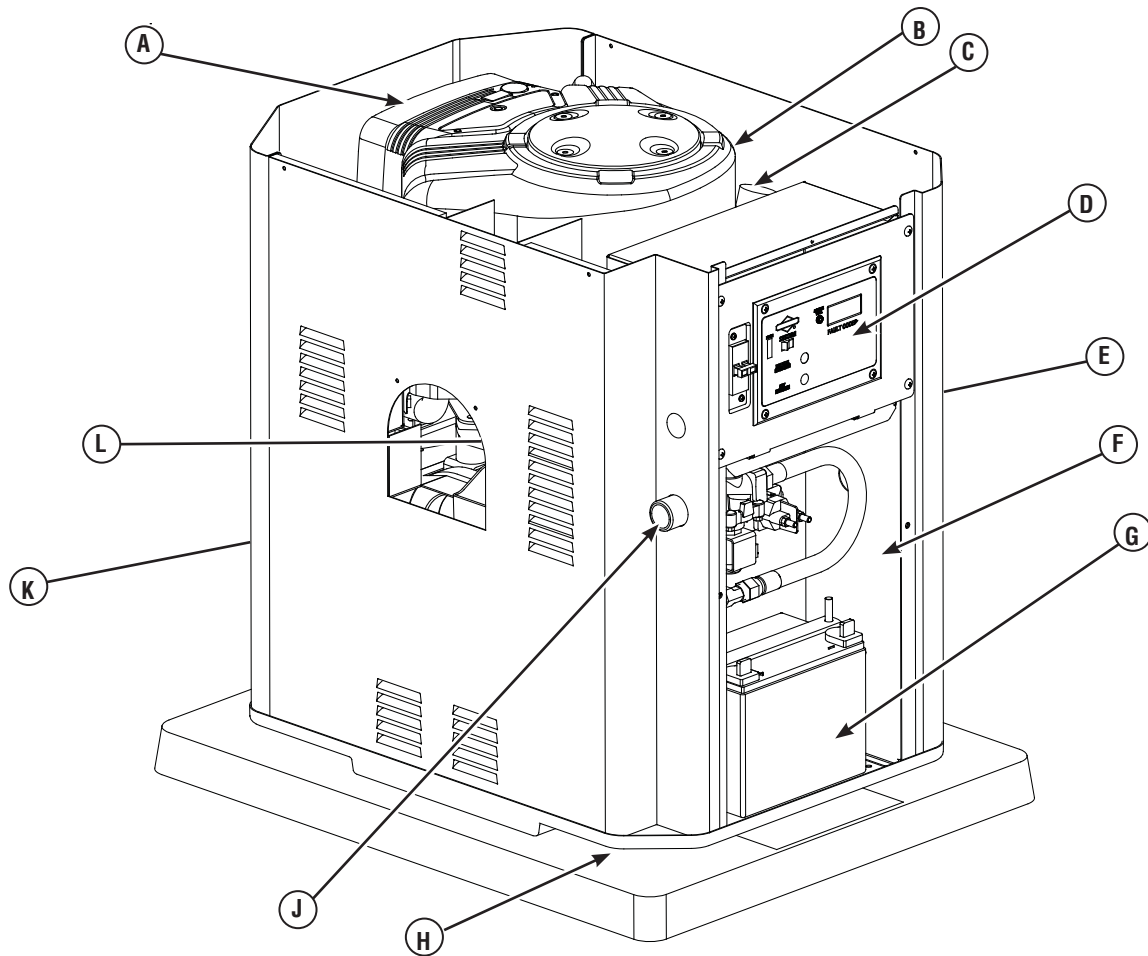

Generator is shown with roof, plastic access cover and control panel cover removed for clarity.

A - Air Cleaner — Uses a dry type filter element and foam precleaner to protect engine by filtering dust and debris out of intake air.

B - Engine Label — Identifies engine model and type.

C - Oil Fill Cap/Dipstick — Check and fill engine with recommended oil here.

D - Control Panel — Used for various test, operation and maintenance functions. See *System Control Panel* on the next page.

E - Oil Drain Hose — Located inside access cover on side panel. Provided to facilitate oil changing.

F - Unit Identification Label — Identifies unit by serial number.

G - Battery (installer supplied) — 12 Volt DC, sealed battery provides power to start the engine.

H - Lifting Pocket — Provided at each corner for lifting generator.

J - Fuel Inlet — Attach appropriate fuel supply to generator here.

K - Exhaust Port — High-performance muffler lowers engine noise to comply with most residential codes.

L - Oil Filter — Filters engine oil to prolong generator life.

System Control Panel

Compare this Control Panel illustration with your generator to familiarize yourself with the location of these important controls:

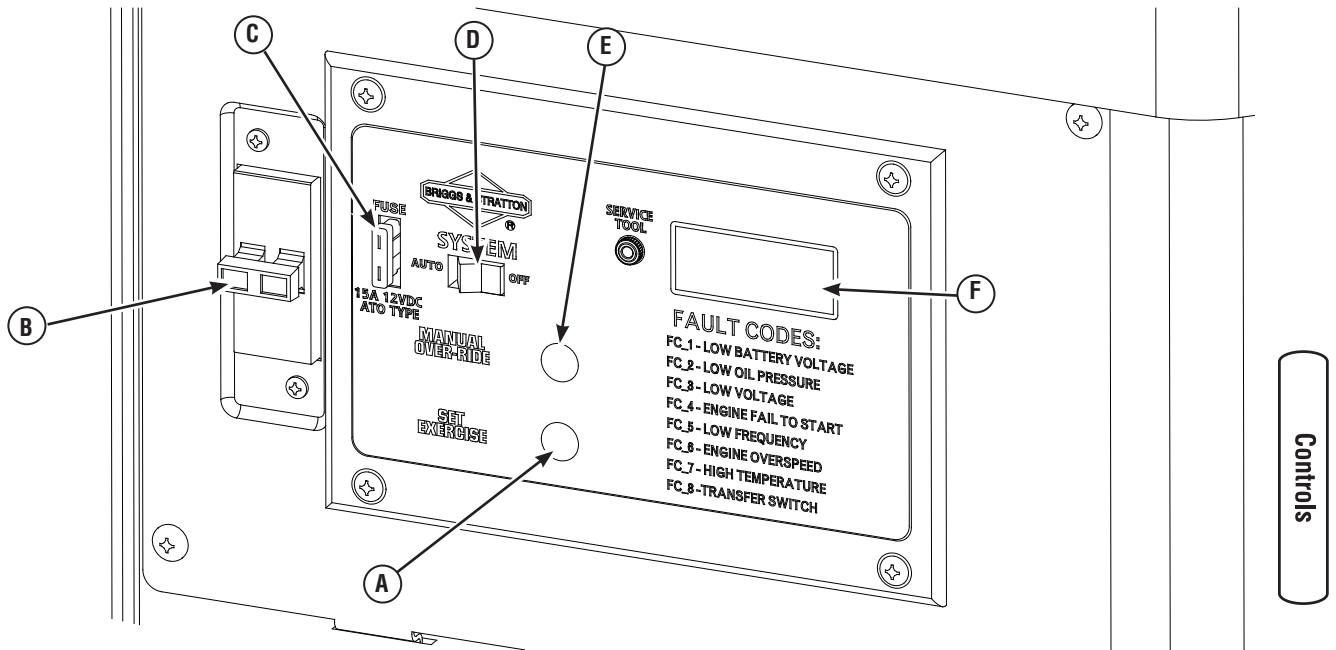

A - Set Exercise Switch — Used to set the exercise cycle start time and day-of-the-week. Exercise cycle only occurs in AUTO mode.

B - Circuit Breaker — Protects the generator from shorts and other over-current conditions. Must be **ON** to supply power to the Automatic Transfer Switch.

C - 15 Amp Fuse — Protects the home generator DC control circuits. If the fuse has 'blown' (melted open) or was removed, the engine cannot crank or start. Replace the fuse using only an identical ATO 15A fuse.

D - System Switch — This two-position switch is the most important control on the system and is used as follows:

- “**AUTO**” position is the normal operating position. If a utility power outage is sensed, the system will start the generator. When utility power is restored, AUTO lets the engine stabilize internal temperatures, shuts off the generator, and waits for the next utility power outage.

- “**OFF**” position turns off running generator, prevents unit from starting and resets any detected faults.

E - Manual Over-Ride Switch — With system switch in AUTO position, push the manual over-ride switch to start the generator. To turn off the generator, push and hold the manual over-ride switch again until engine stops.

F - Digital Display — Displays the total number of hours the generator has been running and fault codes. Used to schedule maintenance tasks and for troubleshooting operational problems with the home generator. All fault conditions are described in *Fault Detection System*.

Access Covers

The home generator is equipped with an enclosure that has a removable roof and an access cover for the control panel.

To Remove Roof:

Remove the four screws and lift off.

To Remove Access Cover:

1. Remove roof as described above.
2. Remove screw at top of access cover.
3. Pull access cover outward (away) from unit while pulling cover upward and out of base. cover will come free.

To Install Access Cover and Roof:

1. Guide bottom of access cover into base.
2. Push access cover until it is flush with sides.
3. Replace cover screw.
4. Replace roof and screws.

Operation

Important Owner's Considerations

Engine Oil

This engine is shipped from the factory filled with the recommended oil. Before starting the engine, check oil level and ensure that engine is serviced as described in the engine operator's manual. See *Engine Oil* in *Maintenance*.

NOTICE

Any attempt to crank or start the engine before it has been properly serviced with the recommended oil will result in equipment failure.

- Refer to *Maintenance* and engine manual for oil fill information.
- Damage to equipment resulting from failure to follow this instruction will void engine and generator warranty.

Battery

The installer must supply and install a sealed, valve-regulated, lead-acid rechargeable starting battery. The starting battery **MUST** conform to the specifications shown below in the chart.

Battery Specifications	
Volts	12 Volt DC
Amps (MIN)	350 CCA (cold cranking amps)
Type	AGM
Terminal Hardware	M8
Dimensions (MAX):	
Width	5.325 inches (135mm)
Length	7.875 inches (200mm)
Height	6.875 inches (175mm)

NOTE: DO NOT use a deep-cycle or automotive type battery.

With the battery installed, all wiring to transfer switch and home generator completed, utility power supplied to the Automatic Transfer Switch, and the system switch in the AUTO position, the battery receives a trickle charge while the engine is not running. The trickle charge cannot be used to recharge a battery that is completely discharged.

WARNING

Battery posts, terminals and related accessories contain lead and lead compounds - chemicals known to the State of California to cause cancer and reproductive harm. Wash hands after handling.

15 Amp Fuse

The generator's 15 Amp fuse was removed at the factory to prevent the unit from starting during shipping. Your installer will ensure the fuse is properly installed upon completion of the installation.

Automatic Operation

To select automatic operation, do the following:

1. Set the service disconnect or main distribution panel circuit breaker that sends utility voltage to the transfer switch to **ON**.
2. Set the generator's main circuit breaker to its **ON** position.
3. Set the system switch to **AUTO**.

CAUTION



With the system switch set to AUTO, the engine may crank and start at any time without warning. Such automatic starting normally occurs when utility source voltage drops below a preset level or during the normal exercise cycle.

- To prevent possible injury that may be caused by such sudden starts, always set the system switch to OFF.
- Remove the 15 Amp fuse before working on or around the generator or transfer switch.

Checking Automatic Operation

To check the system for proper automatic operation, proceed as follows:

1. Turn **OFF** the service disconnect or main distribution panel circuit breaker sending power to the automatic transfer switch.

The engine will crank and start when the utility voltage drops out and the sensor has timed out. Let the system go through its entire automatic operation sequence.

2. With the generator output supplying its loads, turn **ON** the service disconnect or main distribution panel circuit breaker that supplies utility power to the Automatic Transfer Switch.
3. The automatic transfer switch will transfer loads back to the utility power after 5 minute minimum run time and utility is restored.

- The generator will run for an additional one minute for engine cool down, then shut down.

NOTE: If utility is restored and generator does not shut down after 10 minutes, set system switch to **OFF** and contact your installer or local service center.

This completes the test procedures for automatic operation. The home generator will now start automatically when utility power is lost and will supply power to the transfer switch.

Setting Exercise Timer

The home generator is equipped with an exercise timer that will start and exercise the system once every seven days. During this exercise period, the unit runs for approximately 20 minutes and then shuts down. Electrical load transfer DOES NOT occur during the exercise cycle (unless a utility power outage occurs).

A switch on the control panel is labeled “Set Exercise” (see *System Control Panel*). The specific day and the specific time of day this switch is pressed is programmed into the control board memory. This date and time is then used to automatically initiate the system exercise cycle. The “SET EXERCISE” legend on the control panel will flash until the set exercise cycle is set.

To perform the Set Exercise procedure:

- Choose the day and time you want your home generator to exercise.
- On that day and time, press and hold down the “Set Exercise” switch for three seconds.

NOTE: “SET EXERCISE” will flash until the switch is pressed for three seconds, then “SET EXERCISE” will illuminate for 5 seconds, and finally turn off.

- The unit will then start and run it’s 20 minute exercise cycle.

For example, if you press the “Set Exercise” button on Sunday morning at 10:00 AM, the unit will run an immediate exercise cycle and then the following Sunday at 10:00 AM (+/- 1/2 hour).

NOTE: “Set Exercise” will only work if the unit is in the Automatic mode and this exact procedure is followed. The exerciser will need to be re-set if the 15 Amp fuse is removed or changed, or if the 12 Volt DC battery is disconnected.

If you want to change the day and time the unit exercises, simply perform the “Set Exercise” procedure at the exact weekday and time you want it to take place.

Maintenance

Servicing the System

To service system:

- Set the system switch to **OFF**.
- Set the generator’s main circuit breaker to its **OFF** position.
- Utility voltage is present. Disconnect power before servicing by removing the two 2 Amp fuses from the transfer switch.

Fault Detection System

The generator may have to run for long periods of time with no operator present. For that reason, the system is equipped with sensors that automatically shut down the generator in the event of potentially damaging conditions, such as low oil pressure, high temperature, over speed, and other conditions.

The generator’s control panel has a digital display that shows fault codes, like “FC_1”. The table below lists the detected fault, the fault code as displayed on the control panel, and the number of blinks seen on the remote LED indicator.

Fault Description	Fault Codes	LED Flashes
Low battery voltage	FC_1	1
Low oil pressure	FC_2	2
Low voltage	FC_3	3
Engine fails to start	FC_4	4
Low frequency	FC_5	5
Engine overspeed	FC_6	6
High temperature	FC_7	7
Transfer switch fault	FC_8	8

The remote LED indicator is installed at a convenient inside location. The LED will remain lit when the generator is in AUTO. The LED will turn on and off in a series of blinks that correspond to the fault detected in your home generator. The blink pattern is repeated with a brief pause between each series of blinks.

Reset Fault Detection System

The operator must reset the fault detection system each time it activates. To do so, place the system switch in the **OFF** position for 5 seconds or more. Remedy the fault condition, then return the home generator to service by placing the system switch in the **AUTO** position.

A description of each fault and suggested remedies are as follows:

 WARNING
Battery posts, terminals and related accessories contain lead and lead compounds, chemicals known to the State of California to cause cancer and reproductive harm. Wash hands after handling.

No LED - Discharged Battery

If there is a detected fault condition but the LED is not blinking, this is because the battery is completely discharged. To remedy the problem, remove the 15 Amp fuse and disconnect the battery from the generator. Take the battery to a local battery store for analysis. Replace **ONLY** with same type battery as described in *Battery in Operation*. Replace the battery after it has been fully recharged, connecting the **NEGATIVE** cable last. Then install the 15 Amp fuse in the control panel.

NOTE: With the battery installed, all wiring to transfer switch and home generator completed, utility power supplied to the Automatic Transfer Switch, and the unit in AUTO mode, the battery receives a trickle charge while the engine is not running. The trickle charge is not able to recharge a battery that is completely discharged. See *Battery* in *Maintenance*.

Low Battery Voltage

This fault is indicated by fault code FC_1 and one blink on the LED indicator. This condition occurs if the generator cannot start because the starting battery output power is below that needed to crank the engine. Causes for this problem may be a faulty battery or battery charge circuit.

To remedy the problem, contact your local service center to check the battery charge output. Remove the 15 Amp fuse and disconnect the battery from the generator. Take the battery to a local battery store for analysis. Replace **ONLY** with same type battery as described in *Battery* in *Operation*.

Replace the battery after it has been fully recharged, connecting the **NEGATIVE** cable last. Then install the 15 Amp fuse.

Low Oil Pressure

This fault is indicated by fault code FC_2 and two blinks on the remote LED indicator. The unit is equipped with an oil pressure switch **(A)**.

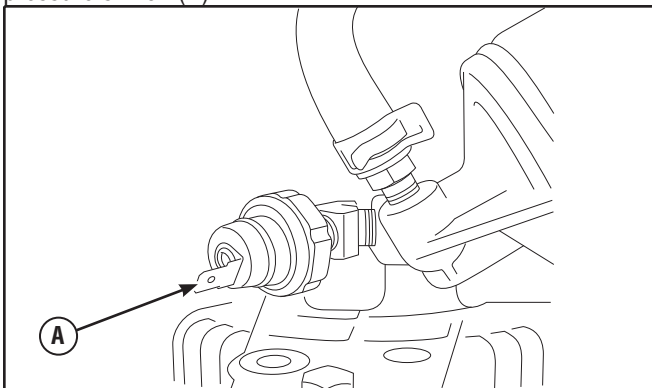

The oil pressure switch uses normally closed contacts that are held open by engine oil pressure during operation. Should oil pressure drop below the 8 psi range, switch contacts close and the engine is shut down.

To remedy the low oil pressure condition, add the recommended oil to the FULL mark on the dipstick.

If the low oil pressure condition still exists, the engine will start, then shut down after about 20 seconds. The fault code will appear and the LED will flash. In this case, contact a Briggs & Stratton Authorized Dealer.

Low Voltage (Generator)

This fault is indicated by fault code FC_3 and three blinks on the LED indicator. This condition is caused by a restriction in the fuel flow, a broken or disconnected signal lead, a failed alternator winding, the control panel circuit breaker is open, or the generator is overloaded.

To remedy the problem, contact your installer or a Briggs & Stratton Authorized Dealer.

Engine Fail To Start

This fault is indicated by fault code FC_4 and four blinks on the LED indicator. This feature prevents the generator from damaging itself if it continually attempts to start in spite of another problem, such as no fuel supply. Each time the system is directed to start, the unit will crank for 10 seconds, pause for 10 seconds, and repeat. If the system does not begin producing electricity after approximately 2 minutes, the unit will stop cranking and the LED will blink.

Check to make sure the generator's main circuit breaker is in the **ON** position in order for the sensing leads to verify that the unit is running.

The most likely cause of this problem is no fuel supply. Check the inside and outside fuel shut off valves to ensure they are fully open. Other causes could be failed spark plug(s), failed engine ignition, or the engine air filter is clogged. You may need to contact your installer for assistance if you can't remedy these problems.

Low Frequency

This fault is indicated by fault code FC_5 and five blinks on the LED indicator. This feature protects devices connected to the transfer switch by shutting the generator down if the engine runs slower than 55 Hz for three seconds. This condition is caused by a failed engine governor or by excessive loads on the generator. To remedy the problem, contact your installer or a Briggs & Stratton Authorized Dealer.

Engine Overspeed

This fault is indicated by fault code FC_6 and six blinks on the LED indicator. This feature protects devices connected to the transfer switch by shutting the generator down if the engine happens to run faster than the preset limit. The overspeed fault is detected as follows:

- If the generator output frequency is 65-70 Hz, after three seconds, the generator will shut down.
- If the generator output frequency is greater than 70 Hz, the generator will shut down immediately.

This condition is caused by a failed engine governor. To remedy the problem, contact your installer or a Briggs & Stratton Authorized Dealer.

High Temperature

This fault is indicated by fault code FC_7 and seven blinks on the LED indicator. The contacts of the temperature switch (A) are normally open. If the engine oil temperature exceeds approximately 148.9°C (300°F), the fault is detected and the engine shuts down.

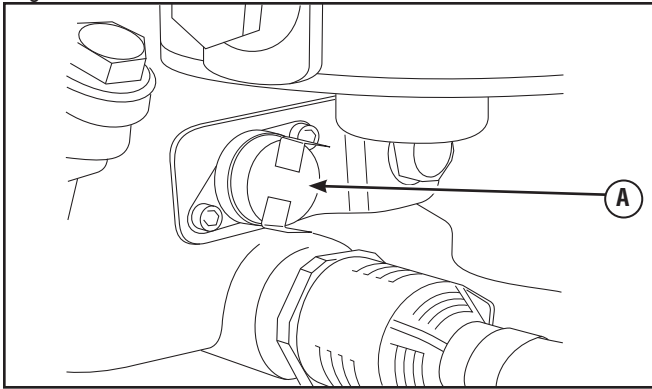

Common causes for this condition include running the unit with all access covers removed, obstructed air inlet or exhaust port, low oil level, or debris in the engine cylinder cooling fins.

To resolve the problem, let the engine cool down and remove any accumulated debris and obstructions. Ensure that the access covers are installed whenever the unit is running.

Transfer Switch Fault

This fault is indicated by fault code FC_8 and eight blinks on the LED indicator (if transfer switch is equipped with fault detection). The most likely cause of this fault is a blown fuse in the transfer switch.

To remedy the problem, contact your installer or a Briggs & Stratton Authorized Dealer.

Generator Maintenance

The generator warranty does not cover items that have been subjected to operator abuse or neglect. To receive full value from the warranty, the operator must maintain the system as instructed in the engine operator's manual.

All adjustments should be made at least once each season. Follow the requirements in the engine operator's manual.

Generator maintenance consists of keeping the unit clean. Operate the unit in an environment where it will not be exposed to excessive dust, dirt, moisture or any corrosive vapors. Cooling air louvers on the enclosure must not become clogged with snow, leaves, or any other foreign material. To prevent generator damage caused by overheating, keep the enclosure cooling inlets and outlets clean and unobstructed at all times.

Check the cleanliness of the unit frequently and clean when dust, dirt, oil, moisture or other foreign substances are visible on its exterior/interior surface. Inspect the air inlet and outlet openings inside and outside the enclosure to ensure air flow is not blocked.

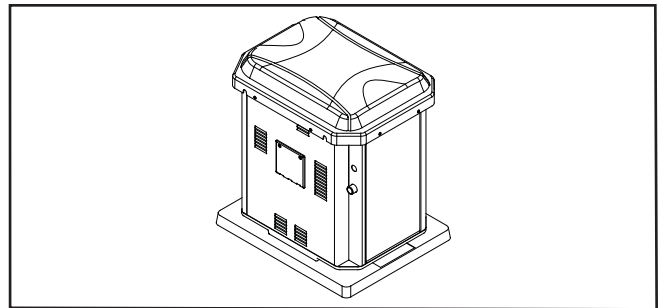

NOTE: DO NOT use direct spray from a garden hose to clean generator. Water can enter the engine and generator and cause problems.

Engine Oil

The system is filled with synthetic oil (API SJ/CF 5W-30W). This allows for system operation in the widest range of temperature and climate conditions.

NOTE: The use of synthetic oil **does not** alter the required oil change intervals described in the engine operator's manual.

Changing Engine Oil and Filter

Remove the two screws from each plastic access cover and remove both access covers from the two sides of the generator enclosure.

Changing Oil

1. Place the oil drain tube into an approved container.
2. Remove brass plug from tube opposite of engine.

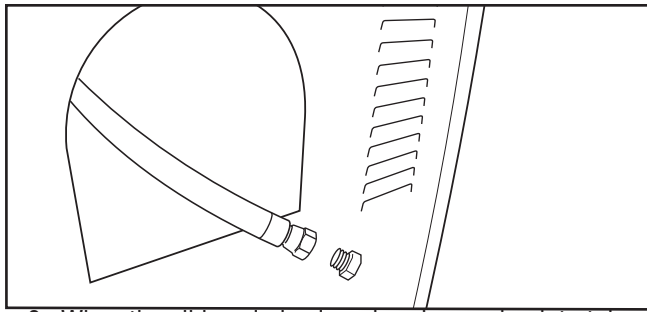

3. When the oil has drained, replace brass plug into tube.
4. Slide the oil drain tube up into the clamp on the fuel hose.

Changing Oil Filter

1. Place oil drain tray over tubing and slide it under oil filter.
2. Follow instructions given in engine operator's manual for changing oil filter.
3. Remove oil drain tray from under oil filter and clean up any spilled oil.

CAUTION

Avoid prolonged or repeated skin contact with used motor oil.

- Used motor oil has been shown to cause skin cancer in certain laboratory animals.
- Thoroughly wash exposed areas with soap and water.



KEEP OUT OF REACH OF CHILDREN. DON'T POLLUTE. CONSERVE RESOURCES. RETURN USED OIL TO COLLECTION CENTERS.

To fill your engine with oil:

Follow the synthetic oil grade recommendation and oil fill instructions given in the engine operator's manual.

NOTICE

Any attempt to crank or start the engine before it has been properly serviced with the recommended oil will result in equipment failure.

- Refer to *Maintenance* and engine manual for oil fill information.
- Damage to equipment resulting from failure to follow this instruction will void engine and generator warranty.

Battery

Servicing of batteries are to be performed or supervised by personnel knowledgeable of batteries and the required precautions. Keep unauthorized personnel away from batteries.

WARNING

Battery posts, terminals and related accessories contain lead and lead compounds - chemicals known to the State of California to cause cancer and reproductive harm. Wash hands after handling.

Charging the Battery

If it is necessary to charge the battery, proceed as follows:

1. Set generator's system switch to **OFF**.
2. Remove 15 Amp fuse from control panel.
3. Disconnect negative battery cable to negative battery terminal (indicated by **NEGATIVE, NEG,** or **(-)**).

NOTICE

Failure to disconnect negative battery cable will result in equipment failure.

- DO NOT attempt to jump start the battery.
- Damage to equipment resulting from failure to follow this instruction will void warranty.

4. Charge battery with battery charger at 2 Amps until battery holds 12 Volts.

NOTE: DO NOT exceed 13.7 Volts charging.

WARNING



Storage batteries give off explosive hydrogen gas during recharging.

Slightest spark will ignite hydrogen and cause explosion.



Battery electrolyte fluid contains acid and is extremely caustic.

Contact with battery contents will cause severe chemical burns.





A battery presents a risk of electrical shock and high short circuit current.

- DO NOT dispose of battery in a fire.
- DO NOT allow any open flame, spark, heat, or lit cigarette during and for several minutes after charging a battery.
- DO NOT open or mutilate the battery.
- Wear protective goggles, rubber apron, and rubber gloves.
- Remove watches, rings, or other metal objects.
- Use tools with insulated handles.

NOTE: With the battery installed and utility power available to the transfer switch, the battery receives a trickle charge whenever the engine is not running. It may take up to 72 hours to fully charge a battery with the trickle charge. The trickle charge is not able to recharge a battery that is completely discharged.

5. Connect negative battery cable to negative battery terminal (indicated by **NEGATIVE, NEG,** or (-)).
6. Ensure hardware on both positive and negative battery terminals is secure.
7. Reinstall 15 Amp fuse in control panel.

 CAUTION	
	Installing the 15A fuse could cause the engine to start.
<ul style="list-style-type: none"> • DO NOT install this fuse until all plumbing and wiring has been completed and inspected. 	

8. Set generator's system switch to **AUTO**.

Servicing the Battery

If it is necessary to service the battery, proceed as follows:

1. Remove "Control Panel" access cover.
2. Set generator's system switch to **OFF**.
3. Remove 15 Amp fuse from control panel.
4. Service or replace battery as required.
5. Connect red battery cable to battery positive terminal (indicated by **POSITIVE, POS,** or (+)).
6. Connect negative battery cable to negative battery terminal (indicated by **NEGATIVE, NEG,** or (-)).
7. Ensure hardware on both positive and negative battery terminals is secure.
8. Reinstall 15 Amp fuse in control panel.
9. Set generator's system switch to **AUTO**.
10. Install "Control Panel" access cover.
11. Reset exercise timer. See *Setting Exercise Timer*.

To Clean the Generator

NOTICE
Improper treatment of generator can damage it and shorten its life.
<ul style="list-style-type: none"> • DO NOT expose generator to excessive moisture, dust, dirt, or corrosive vapors. • DO NOT insert any objects through cooling slots.

- Use a damp cloth to wipe exterior surfaces clean.
- Use a soft, bristle brush to loosen caked on dirt, oil, etc.
- Use a vacuum cleaner to pick up loose dirt and debris.
- Use low pressure air (not to exceed 25 psi) to blow away dirt. Inspect cooling air slots and openings on the generator. These openings must be kept clean and unobstructed.

When Calling the Factory

You must have the following information at hand if it is necessary to contact a local service center regarding service or repair of this unit:

1. Obtain the unit Model Number and Serial Number from the unit data decal. See *Controls*.
2. Obtain the engine Model/Type/Code numbers from the engine label. See *Controls*. Please note that the model number may vary slightly from that presented herein.

Storage

The Briggs & Stratton home generator is designed for continuous backup operational duty. As such, there is no need to take any storage precautions. However, if it becomes necessary to take the system out of service for an extended period, call Briggs and Stratton Technical Services at **(800) 743-4115**, between 8:00 AM and 5:00 PM CT for specific recommendations.

Reserved

Troubleshooting

Problem	Cause	Correction
Engine is running, but no AC output is available.	<ol style="list-style-type: none"> 1. Circuit breaker open or defective. 2. Fault in generator. 3. Poor wiring connections or defective transfer switch. 	<ol style="list-style-type: none"> 1. Reset or replace circuit breaker. 2. Contact local service facility. 3. Check and repair.
Engine runs good at no-load but “bogs down” when loads are connected.	<ol style="list-style-type: none"> 1. Short circuit in a connected load. 2. Generator is overloaded. 3. Shorted generator circuit. 4. Fuel Pressure is incorrect. 5. Natural gas fuel mixture is incorrect. 6. Kinked fuel line between regulator and engine. 	<ol style="list-style-type: none"> 1. Disconnect shorted electrical load. 2. See <i>Essential Circuits</i>. 3. Contact local service facility. 4. See <i>Gaseous Fuel System</i> in the Installation Manual. 5. See <i>Gaseous Fuel System</i> in the Installation Manual. 6. Remove kink in fuel line. Replace if necessary.
Engine will not start; or starts and runs rough.	<ol style="list-style-type: none"> 1. 15 Amp fuse missing or blown. 2. Fuel supply turned off, restricted or depleted. 3. Failed battery. 4. Clogged air filter. 	<ol style="list-style-type: none"> 1. Install (new) 15 Amp fuse. See <i>System Control Panel</i>. 2. Open fuel valve(s); check propane tank. 3. Replace battery. 4. Clean or replace air filter.
Engine shuts down during operation.	<ol style="list-style-type: none"> 1. Fuel supply turned off, restricted or depleted. 2. Fault indicator blinking. 	<ol style="list-style-type: none"> 1. Check fuel valves, fill propane tank. 2. Count blinks and refer to <i>Fault Detection System</i>.
Loss of power on essential circuits.	<ol style="list-style-type: none"> 1. Generator circuit breaker is open. 2. Transfer switch problems. 	<ol style="list-style-type: none"> 1. Reset circuit breaker. 2. See the transfer switch manual.

Schematic

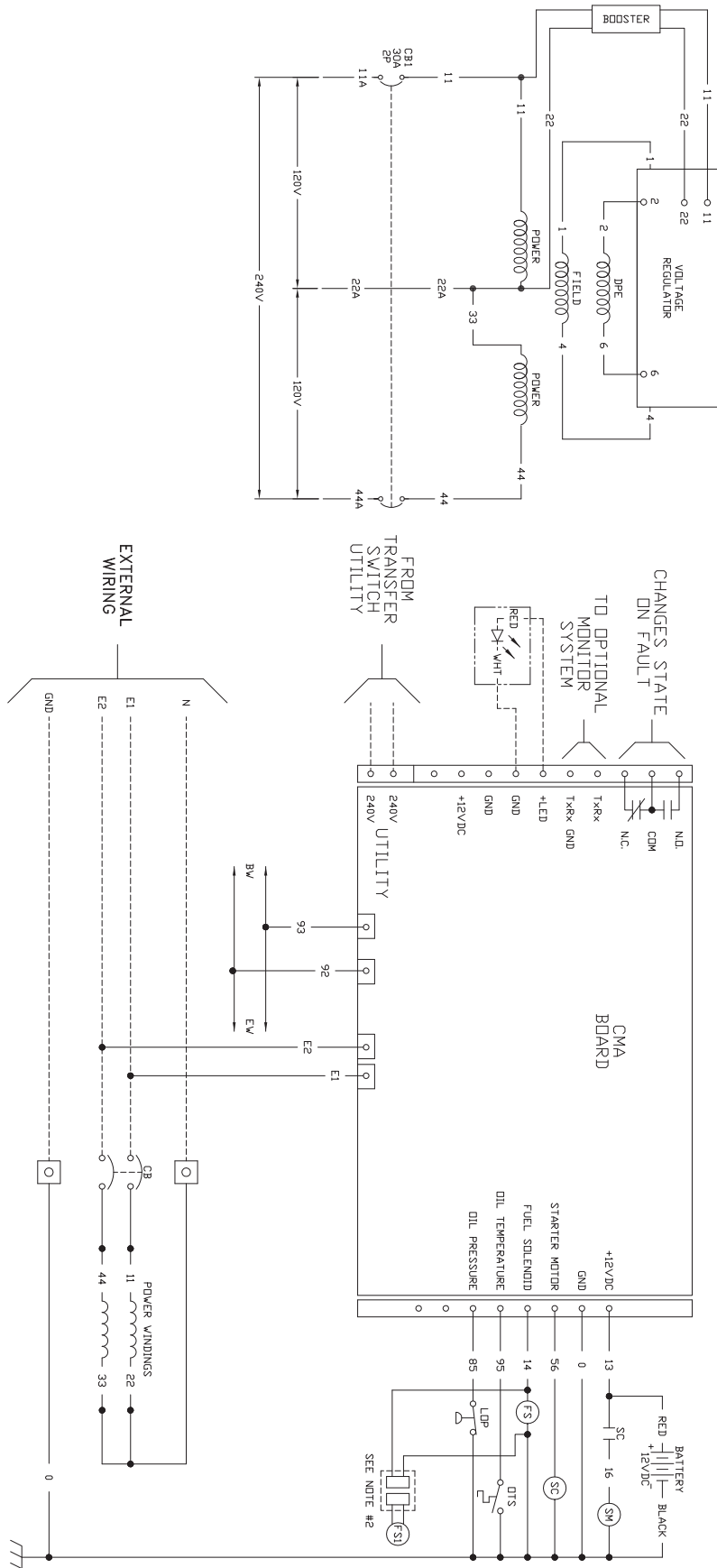

Troubleshooting

BRIGGS & STRATTON POWER PRODUCTS GROUP, LLC 10kW HOME GENERATOR OWNER WARRANTY POLICY

Effective March 1, 2008. Replaces all undated Warranties and all Warranties dated before March 1, 2008

LIMITED WARRANTY

Briggs & Stratton Power Products Group, LLC will repair or replace, free of charge, any part(s) of the equipment that is defective in material or workmanship or both. Transportation charges on product submitted for repair or replacement under this warranty must be borne by purchaser. This warranty is effective for the time periods and subject to the conditions stated below. For warranty service, find the nearest Authorized Service Dealer in our dealer locator map at BRIGGSandSTRATTON.COM.

THERE IS NO OTHER EXPRESS WARRANTY. IMPLIED WARRANTIES, INCLUDING THOSE OF MERCHANTABILITY AND FITNESS FOR A PARTICULAR PURPOSE, ARE LIMITED TO ONE YEAR FROM PURCHASE, OR TO THE EXTENT PERMITTED BY LAW. ANY AND ALL IMPLIED WARRANTIES ARE EXCLUDED. LIABILITY FOR INCIDENTAL OR CONSEQUENTIAL DAMAGES ARE EXCLUDED TO THE EXTENT EXCLUSION IS PERMITTED BY LAW. Some states or countries do not allow limitations on how long an implied warranty lasts, and some states or countries do not allow the exclusion or limitation of incidental or consequential damages, so the above limitation and exclusion may not apply to you. This warranty gives you specific legal rights and you may also have other rights which vary from state to state or country to country.

WARRANTY PERIOD

Consumer Use	3 years or 1250 hours, whichever comes first
Commercial Use	None

The warranty period begins on the date of purchase by the first retail consumer or commercial end user, and continues for the period of time stated in the table above. "Consumer use" means personal residential household use by a retail consumer. "Commercial use" means all other uses, including use for commercial, income producing or rental purposes. Once equipment has experienced commercial use, it shall thereafter be considered as commercial use for purposes of this warranty.

NO WARRANTY REGISTRATION IS NECESSARY TO OBTAIN WARRANTY ON BRIGGS & STRATTON PRODUCTS. SAVE YOUR PROOF OF PURCHASE RECEIPT. IF YOU DO NOT PROVIDE PROOF OF THE INITIAL PURCHASE DATE AT THE TIME WARRANTY SERVICE IS REQUESTED, THE MANUFACTURING DATE OF THE PRODUCT WILL BE USED TO DETERMINE THE WARRANTY PERIOD.

ABOUT YOUR WARRANTY

We welcome warranty repair and apologize to you for being inconvenienced. Any Authorized Service Dealer may perform warranty repairs. Most warranty repairs are handled routinely, but sometimes requests for warranty service may not be appropriate. For example, warranty service would not apply if equipment damage occurred because of misuse, lack of routine maintenance, shipping, handling, warehousing or improper installation. Similarly, the warranty is void if the manufacturing date or the serial number on the equipment has been removed or the equipment has been altered or modified. During the warranty period, the Authorized Service Dealer, at its option, will repair or replace any part that, upon examination, is found to be defective under normal use and service. This warranty will not cover the following repairs and equipment:

- **Normal Wear:** Outdoor Power Equipment and engines, like all mechanical devices, needs periodic parts and service to perform well. This warranty does not cover repair when normal use has exhausted the life of a part or the equipment.
- **Installation and Maintenance:** This warranty does not apply to equipment or parts that have been subjected to improper or unauthorized installation or alteration and modification, misuse, negligence, accident, overloading, overspeeding, improper maintenance, repair or storage so as, in our judgment, to adversely affect its performance and reliability. This warranty also does not cover normal maintenance such as adjustments, fuel system cleaning and obstruction (due to chemical, dirt, carbon, lime, and so forth).
- **Other Exclusions:** This warranty excludes starting batteries and wear items such as oil gauges, o-rings, filters, fuses, or spark plugs, etc., or damage or malfunctions resulting from accidents, abuse, modifications, alterations, or improper servicing or freezing or chemical deterioration. Accessory parts are excluded from the product warranty. This warranty excludes failures due to acts of God and other force majeure events beyond the manufacturers control. Also excluded is used, reconditioned, and demonstration equipment; equipment used for prime power in place of utility power and equipment used in life support applications. 207581E, Rev. - 6/3/2008

BRIGGS & STRATTON POWER PRODUCTS GROUP, LLC
JEFFERSON, WI, USA

Reserved

Home Generator Systems

Product Specifications

Rated Maximum Load Current:
at 120 Volts 83.33 Amps
at 240 Volts 41.66 Amps
Rated AC Voltage 120/240 Volts
Phase Single phase
Rated Frequency 60 Hertz
Normal Operating Range . . -20°F (-28.8°C) to 104°F (40°C)
Output Sound Level . 70 dB(A) at 23 ft. (7 m) at normal load

This generator is rated in accordance with UL (Underwriters Laboratories) 2200 (stationary engine generator assemblies) and CSA (Canadian Standards Association) standard C22.2 No. 100-04 (motors and generators).

Briggs & Stratton Power Products Group, LLC
900 N. Parkway
Jefferson, Wisconsin, 53549 U.S.A.