

# RELIANCE

CONTROLS

ELECTRICAL INNOVATION SINCE 1909™

## TRANSFER EQUIPMENT FOR PORTABLE GENERATORS



### INSTALLATION AND OPERATING INSTRUCTIONS

For Power Transfer Kit Models  
31406CRK and 31410CRK

#### TABLE OF CONTENTS

	Page
Tools Needed for Installation	1
Parts List	1
Safety Symbols Used in this Manual	1
About Generators and Transfer Switches	2
Key Product Components	3
Pre-Planning the Load on Your Generator	4
Load Balancing Examples	5
Installation Instructions	
Mounting the Transfer Switch	6
Connecting the Flexible Conduit	6
Grounding the Transfer Switch	7
Installing 120 Volt Circuits	7
Installing 240 Volt Circuits	8
Completing the Installation	8
Installing and Wiring the Power Inlet Box	9
Wiring the Power Inlet Box to the Transfer Switch	9
Installing an Optional Power Inlet	10
Finishing Up	10
Operating Instructions	10
Product Specifications	11

***Congratulations on your purchase of the Reliance Controls generator power transfer switch. Reliance has been manufacturing transfer switches and equipment in Racine, Wisconsin since 1983 and has been producing high-quality electrical equipment for nearly 100 years. Reliance is the Loadside® transfer switch used in nearly 90% of the installations done by professional electricians. Your transfer switch is UL 1008 listed, C-UL listed, and meets all requirements of the 2002 National Electrical Code.***

***All Reliance Controls transfer switches are made to operate with any generator up to 7500 watts continuous output, having 20 or 30 Amp twist-lock power receptacles.***

### **TOOLS NEEDED FOR INSTALLATION**

- |  |   |
|--|---|
| 1. Power Drill   | 6. Tape Measure   |
| 2. Wire Stripper and Cutter (10 to 14 gauge)   | 7. Seven Wall Anchors with at Least a 3/8" Flange   |
| 3. Insulated Screwdrivers<br>(#2 Phillips, 1/4" Flat Tip or #2 Square Tip depending on your load center) | 8. Enough 10-3 with Ground Building Wire to reach from where you install your Outdoor Power Inlet Box to where you install your transfer switch |
| 4. Hammer  | 9. Battery Powered Lighting during Installation   |
| 5. Marking Pencil  | 10. A Non-Contact Voltage Detector (optional)   |

### **PARTS LIST for 31406CRK POWER TRANSFER KIT**

- 30 Amp 6-Circuit Transfer switch
- 30 Amp Outdoor Power Inlet Box
- 30 Amp 10-foot long Generator Power Cord
- 20 Amp Interchangeable Power Cord Plug
- 4 red and 6 yellow wire connectors
- Installation and Operating Instructions

NOTE: The 30 Amp power cord plugs into this type of generator power outlet:



If your generator only has a 20 Amp power outlet like this:



install the 20 Amp Power Cord Plug on your power cord according to its included instructions.

### **SAFETY SYMBOLS USED IN THIS MANUAL**



**DANGER**

Danger indicates an imminently hazardous situation that, if not avoided, could result in death or serious injury.



**WARNING**

Warning indicates a potentially hazardous situation that, if not avoided, could result in death or serious injury.



**CAUTION**

Caution indicates a potentially hazardous situation that, if not avoided, may result in minor or moderate injury.

Transfer switches are required for use with portable generators by Article 702 of the 2002 National Electrical Code



Member of the National Electrical Manufacturers Association

**Reliance Controls Corporation is not responsible for damage or injury caused by incorrect installation of this transfer switch.**



**WARNING**

The double pole branch circuits connected to this transfer switch are to be considered live unless both switches controlling the circuit are in the off position. The position of the circuit breakers are not be relied upon to disconnect the circuit.



**WARNING**

Improper installation of the transfer switch could cause damage or personal injury by electrocution or fire. Installation must be performed by a qualified electrician, or others knowledgeable of electrical systems, in compliance with all applicable electrical codes. Do not overload.

## ABOUT GENERATORS AND TRANSFER SWITCHES

Generators and transfer switches are dependent on one another as a system to power your home in a power out situation. The Reliance Controls transfer switch system is needed because 1) your portable generator is very powerful and the power it creates must be safely controlled to protect you and your electric utility provider, and 2) even with all of its power, your generator probably cannot power all of the electrical circuits and devices in your home without help from a transfer switch with load management capabilities.

The Reliance Controls transfer switch is designed to let you control and distribute your generator's power. It correctly distributes the power from your portable generator to your home circuitry through your electrical load center. It also eliminates the need for messy cords running to your electrical appliances through open doors and windows. The Reliance Controls transfer switch working with your generator takes the worry and inconvenience from power outage situations.

The Reliance Controls transfer switch distributes the power from your generator through its toggle switches to the corresponding selected branch circuits that power the major appliances you choose to operate during a power outage (such as your sump pump, refrigerator or furnace). However, because each of these branch circuits may power several other electrical devices other than your major appliances, such as the items plugged into wall sockets and permanently installed lighting, we recommend that you do a little pre-planning by:

1. Picking the key electrical appliances you want to power in an emergency
2. Finding the essential circuit breakers that control these devices
3. Creating a map of all of the other electrical devices plugged into or wired into these circuits

A tear-off Home Circuit Mapping Chart on the back of this manual should be completed and posted next to your transfer switch to help you in managing the load on your generator. Make sure you note on the chart which electrical devices you will not need during a power outage so that these can be turned off prior to starting your generator.

During a power outage, you can run your generator and transfer switch system in two ways:

- You can set up your transfer switch to run all of its circuits at the same time once you flip the toggles to the GEN position. Setting your system up in this way will be discussed in the "Balancing the Load" section later.
- You can also use the load management function of the Reliance Controls transfer switch that allows you to alternate the devices you choose to run at any given time. If your generator is running at or near its maximum output, selected circuits can be switched off and others can be switched on for brief periods of time. For example, you can run a microwave oven for a brief period from the transfer toggle switch that controls your microwave circuit, if you first turn off the transfer switch toggle switch that controls your furnace—for that same brief period.

### **Typical Generator and Transfer Switch Installations**

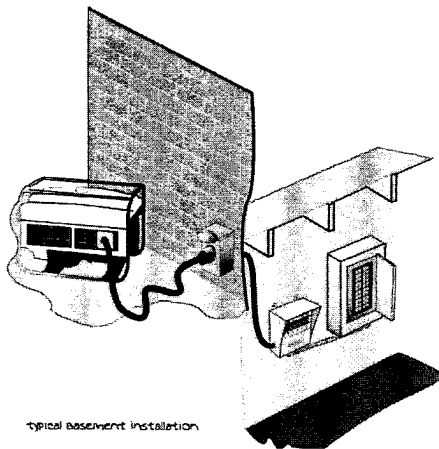

Generator Plugged into Outdoor Power Inlet Box Wired to Transfer Switch Next to Basement Load Center  
(POSSIBLE KIT INSTALLATION)

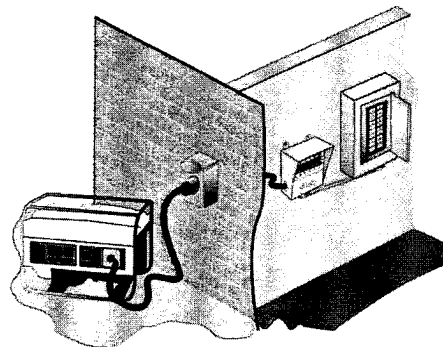

Generator Plugged into Outdoor Power Inlet Box Wired to Transfer Switch Next to Garage Load Center  
(POSSIBLE KIT INSTALLATION)

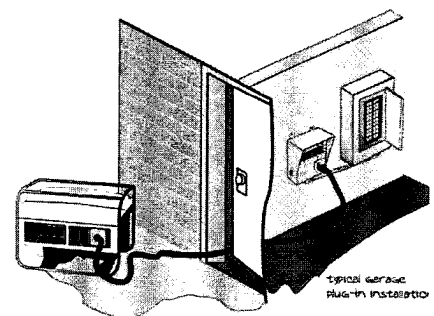

Generator Plugged into Interchangeable Power Inlet on Transfer Switch with 20-foot Cord  
(POSSIBLE INSTALLATION WITH AVAILABLE RELIANCE ACCESSORIES)

# KEY COMPONENTS OF THE RELIANCE CONTROLS TRANSFER SWITCH AND POWER TRANSFER KIT

*Your Reliance Controls transfer switch is unique in two ways: 1) it has a patented internal wiring compartment which eliminates the need for the installation of additional junction boxes, and 2) it has a removable front panel which allows a power inlet to be easily inserted to allow a power cord to be plugged directly into the transfer switch with a longer power cord. Although this is not the installation addressed by the 31406CRK Kit, such an installation may be desirable depending on your situation.*

**Circuit Selector Toggle Switches**  
 These switches allow you to select either GEN (generator) or LINE (utility) as the power source for the branch circuits that have been wired through the transfer switch. The OFF position generally is not used, as a switch in the OFF position removes that circuit both from generator and utility power.

**Wattmeters**  
 Wattmeters indicate the total load on your generator measured in watts resulting from the appliances that are running using generator power. They are calibrated to show how close your generator is to its capacity.

**Knockout Holes**  
 Located on both sides, the bottom and the back of your transfer switch, these knockouts are easily removed with a screwdriver and a hammer and allow the direct wiring of your transfer switch with building wire.

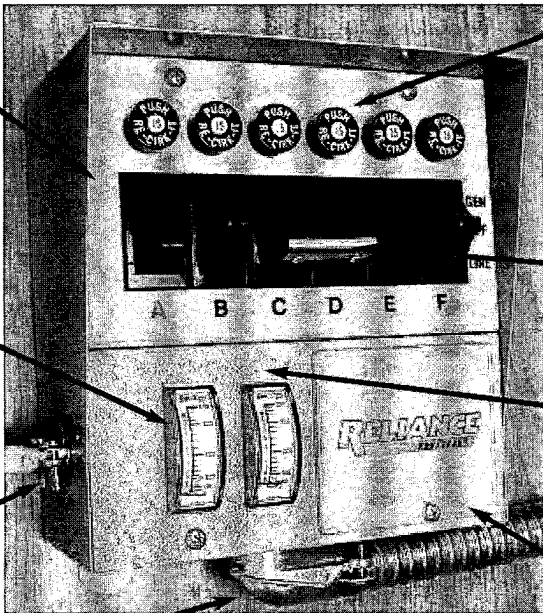

**Branch-Rated Circuit Breakers**  
 Each transfer switch circuit controlled by a toggle switch has a built-in corresponding 15 or 20 Amp push-to rest circuit breaker that protects the branch circuit when the toggle switch is in the GEN position. In the LINE position, each branch circuit is protected by the breaker in the load center.

**Handle Ties**  
 Used to link two 120 Volt circuits together to create a 240 volt circuit to run larger appliances such as a well pump.

**Wiring Compartment Front Plate**  
 Removing the two screws which attach this plate, reveals the internal wiring compartment. Inside are four pre-stripped wires which connect to the incoming generator-powered wires.

**Power Inlet Hole Cover Plate**  
 This logo plate removes with one screw to allow the insertion of an accessory power inlet on the front of your transfer switch to allow direct connection to the generator with a power cord.

**Pre-Wired Flexible Conduit Whip**  
 Contains all of the hot, neutral and ground wires required to make connections between your transfer switch and the circuit breakers in your load center you choose to control. Each wire is color-coded and marked with the switch letter for easy identification.

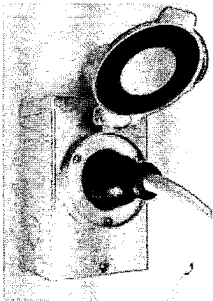

**30 Amp Outdoor Power Inlet Box**

30 Amp NEMA 3-configured outdoor generator Power inlet Box mounts to the outside of your house near to where your generator will be running. It allows direct wiring to your transfer switch and load center from a remote location.

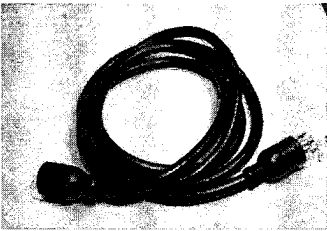

**30 Amp Twist-Lock Power Cord**

30 Amp 10-foot long outdoor-rated power cord has L14-30 connectors. One end plugs into your generator power outlet and the other into the Reliance Power Inlet Box.

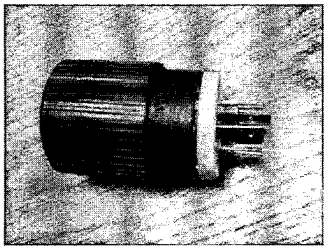

**20 Amp Interchangeable Power Cord Plug**

Allows the use of the Reliance 30 Amp power cord on smaller generators with only 20 Amp power outlets, by replacing the 30 Amp plug on the cord supplied.

## PRE-INSTALLATION PLANNING OF THE GENERATOR LOAD

Before you begin installing your Reliance Controls transfer switch system, you need to create a plan for the appliances you choose to run during a power outage. To do this, it's helpful to first know how your generator produces power. If your generator has four-prong twist-lock 20 or 30 Amp output receptacles, and is set-up for home stand-by operation, it likely will produce 120/240 Volt power, or power similar to your electrical utility. This type of power generation is useful as it: 1) allows common 120 Volt circuits, such as lights or small appliances, to be operated, and 2) allows two 120 Volt circuits to be linked together to operate a 240 Volt device, such as a well pump.

Because of the way in which larger portable generators are designed, they generate power in two equal halves. A generator which has output of 5000 continuous running watts, for example, generates power from two 2500 watt "sides". In setting up a transfer switch to get the most power from your generator, it is desirable to "balance the load" between the two halves of your transfer switch, or the left side and the right side. Devices which will consume the most of the generator's wattage should be divided between the two sides. Load balancing is shown in Figure 1. For example, on the 6-circuit transfer switch shown in Figure 1, consider wiring the breaker controlling the refrigerator to toggle switch A, the furnace breaker to toggle switch B, the sump pump breaker to switch E and the breaker controlling your TV and VCR to toggle switch F. You may want to reserve switches C and D to be linked with a handle tie and wired to a double pole breaker controlling, for example, a 240 Volt well pump.

The Residential Wattage Requirements Table below shows sample wattages used by typical household appliances and can help you plan the set up of your transfer switch. Use the running watts of your appliances rather than starting watts when dividing them between the two halves of the transfer switch. Check your appliances for actual wattage requirements if possible.

Your Reliance Controls transfer switch also allows you to manage the load on your generator manually by switching appliances on and off as you need them, so the capacity of either half of your generator is not exceeded. However, if you prefer not to manage your transfer switch loads manually, leave a buffer equal to the largest start-up wattage requirement of all of the appliances you are going to run continually when doing your calculation. This buffer, along with the peak wattage of your generator, will allow for the periodic motor start-up of any one large appliance, such as your refrigerator. If your transfer switch is equipped with watt meters, you can visually monitor the amount of wattage being used by the appliances your generator is powering at any time.

Examples of load balancing calculations are shown on the worksheets on page 5. Use these to create your own plan.

### TYPICAL RESIDENTIAL WATTAGE REQUIREMENTS

Appliance	Running Wattage	Additional Start-Up Wattage
Furnace (1/3 HP)	700	1,400
Furnace (1/2 HP)	875	2,100
Window Air Conditioner		
6000 BTU	1,200	2,100
12,000 BTU	1,700	2,900
Well Pump (1/3 HP)	750	1,400
Well Pump (1/2 HP)	1,000	2,350
Sump Pump (1/3 HP)	800	1,300
Sump Pump (1/2 HP)	1,050	2,150
Refrigerator	800	2,300
Garage Door Opener (1/4 HP)	550	1,100
Garage Door Opener (1/3 HP)	750	1,400
Home Security System	200	0
Lights	On Bulb	On Bulb
Stereo	200	0
TV/VCR	200	0
Computer	200	0
Microwave	Check oven	Check Oven
Coffee Maker	1,750	0
Toaster	1,300	0
Electric Fan	200	0
Clothes Washer	1,150	2,300
Clothes Dryer (Gas)	700	1,800
Dishwasher (Cool Dry)	700	1,400
Dishwasher (Hot Dry)	1,450	1,400
Vacuum Cleaner	1,000	0
Hair Dryer	Check Dryer	Check Dryer
Iron	1,200	0
Circular Saw	800	2,000

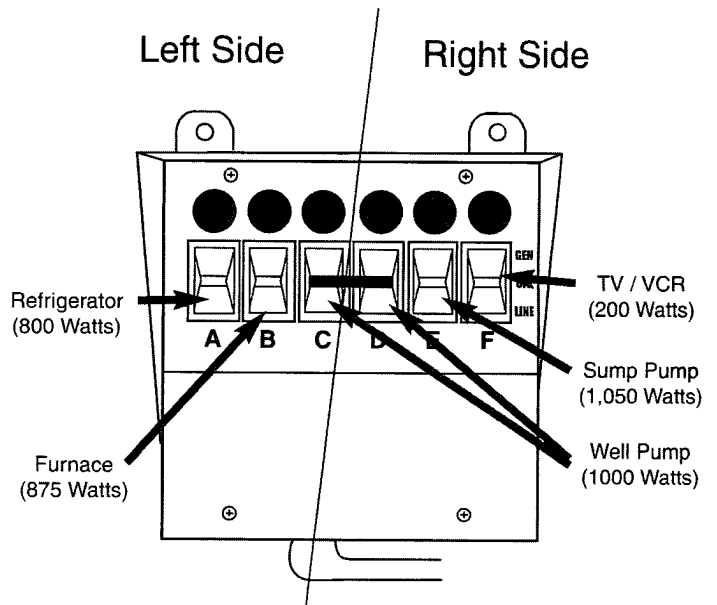

**Figure 1**

## Load Balancing Example #1

**Circuit Breaker Connections:** Six (6) 120 Volt Single Pole Circuit Breakers  
**Generator:** 5,500 Running Watts, 6,200 Peak Watts  
**Transfer Switch Model:** 6-Circuits

Side One				Side Two			
Toggle Switch	Main Appliance Hooked Up	Appliance Running Watts	Additional Start-Up Watts	Toggle Switch	Main Appliance Hooked Up	Appliance Running Watts	Additional Start-Up Watts
A	Refrigerator	800	2,300	F	Furnace	700	1,400
B	Sump Pump	800	1,300	E	TV, VCR, Computer	600	0
C	Indoor Lighting	300	0	D	Security, Lighting	500	0
Total Running Watts Side One: 1,900				Total Running Watts Side Two: 1,800			

**Total Side One and Side Two Running Watts** 3,700  
**Highest Additional Start-Up Wattage of all of the Appliances (Refrigerator)** 2,300  
**Total Watts of Load** 6,000  
**Peak Wattage Rating of Your Generator** 6,200

You're OK!

## Load Balancing Example #2

**Circuit Breaker Connections:** Four (4) 120 Volt Single Pole Circuit Breakers and One (1) 240 Volt Double-Pole Circuit Breaker (Toggles C & D Together)  
**Generator:** 5,500 Running Watts, 6,200 Peak Watts  
**Transfer Switch Model:** 6-Circuits

Side One				Side Two			
Toggle Switch	Main Appliance Hooked Up	Appliance Running Watts	Additional Start-Up Watts	Toggle Switch	Main Appliance Hooked Up	Appliance Running Watts	Additional Start-Up Watts
A	Refrigerator	800	2,300	F	Furnace	700	1,400
B	TV, VCR, Computer	600	0	E	Sump Pump	800	1,300
C	Well Pump	500	1,175	D	WellPump	500	1,175
Total Running Watts Side One: 1,900				Total Running Watts Side Two: 2,000			

**Total Side One and Side Two Running Watts** 3,900  
**Highest Additional Start-Up Wattage of all of the Appliances (Refrigerator)** 2,300  
**Total Watts of Load** 6,200  
**Peak Wattage Rating of Your Generator** 6,200

You're OK Again!

## INSTALLATION INSTRUCTIONS

### A. Mounting the Transfer Switch

1. Position the transfer switch so that its bottom center is about 18 inches from the bottom center of your load center. The end of the flexible conduit whip should be lined up with a 3/4" knockout hole on the bottom of your load center (Figure 2).
2. Mark the position of the holes on the four external feet with a pencil.
3. Anchor the transfer switch to the wall with four appropriate anchors (with a flange of at least 3/8").

**NOTE:** Do not attempt to bend the flexible conduit whip beyond its structural capabilities.

### B. Connecting the Flexible Conduit Whip to Your Load Center

1. Set up battery-powered lighting to clearly illuminate your work area.
2. Turn off the main utility breaker (Figure 3).



Even with the main power switch turned off, the wires on the utility side of the main breaker are still live and contact with them can cause serious injury or death.

3. Remove the cover of your load center. Keep in mind that the wires on the utility side of the main breaker are still live and if contacted could cause serious injury or death. If available, use a non-contact voltage detector to insure that the power is off on the non-utility side of the main breaker.
4. Remove the appropriate knockout hole in the bottom of your load center with a screwdriver and hammer. (See step A-1 above.)
5. Insert all of the wires extending from the end of the flexible conduit whip through the knockout hole. Snap the conduit connector attached to the whip into the knockout hole.

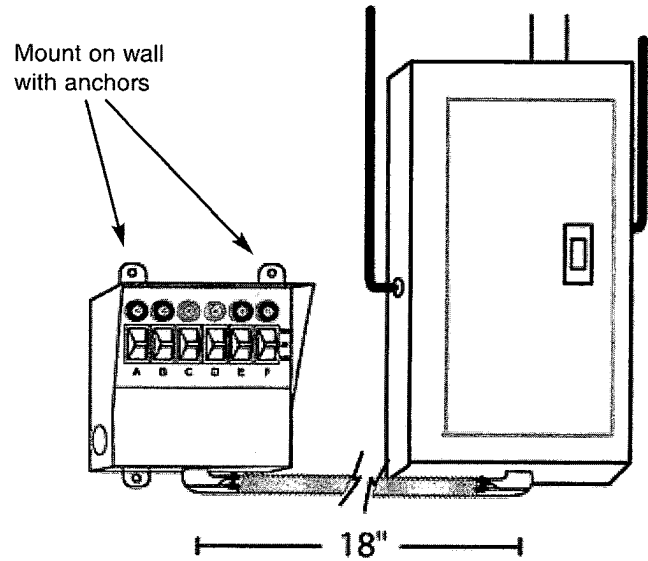

Figure 2

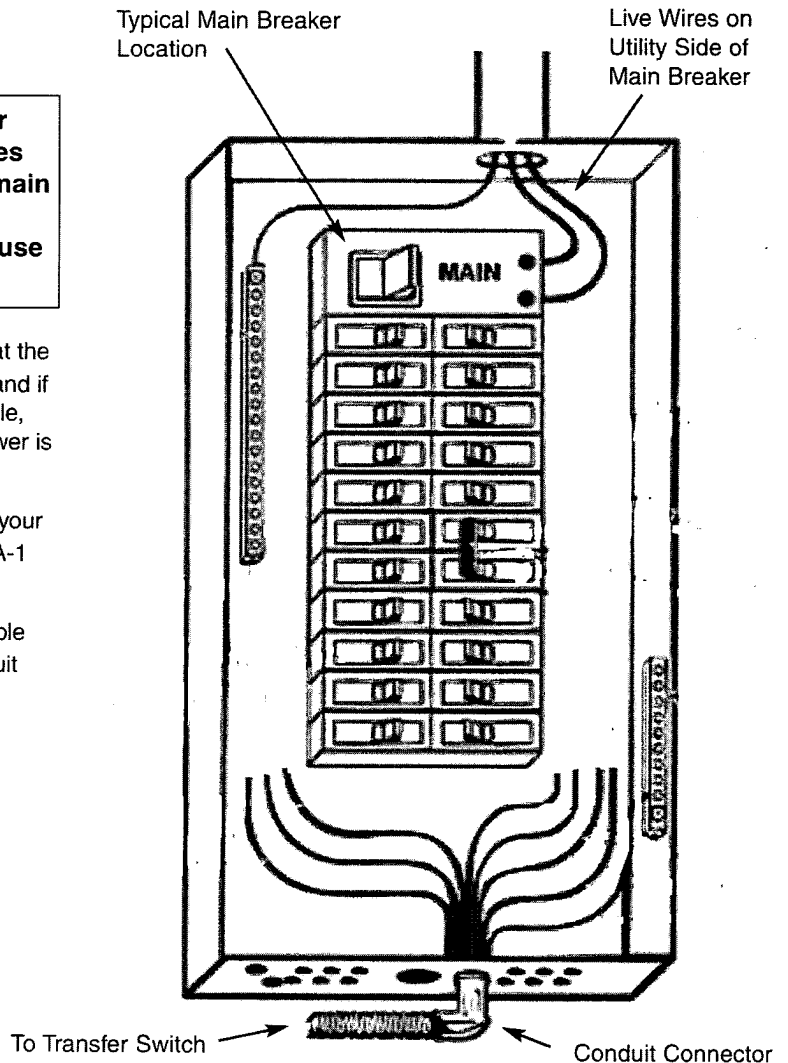

Figure 3

## C. Connecting the Neutral and Ground Wire

1. Find the white wire (Neutral) and the green wire (ground) among the wires from the transfer switch that you have inserted into the load center.
2. Strip approximately 5/8" from the end of the white wire. Locate the neutral bar and partially unscrew a terminal screw on the bar. Insert the stripped end of the wire into the side of the bar under the screw and retighten the screw. (Figure 4)
3. Locate the ground bar. (It should be labeled.) Connect the green wire to the ground bar in the same way as in step #2. In service entrance load centers, the ground bar and neutral bar are frequently the same; if so, the ground and neutral wires can be connected to either.

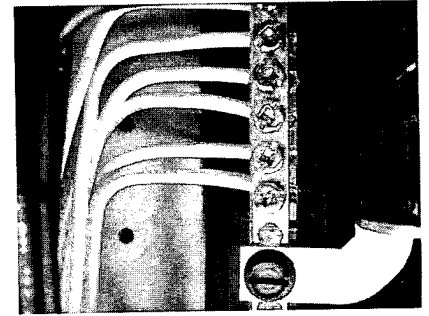

Figure 4

## WARNING When Installing 120 Volt Circuits

The transfer switch circuits with 20 Amp breakers must be connected only to branch circuits with 20 Amp breakers in the load center. Do not connect transfer switch circuits to any branch circuits greater than 20 Amps.  
NOTE: The transfer switch circuits with 15 Amp breakers can be connected to branch circuits with either 15 or 20 Amp breakers in the load center.

## D. Installing 120 Volt Circuits

This section provides instructions for connecting the wires from your transfer switch to the circuit breakers in your load center which control your appliances.

You should refer to the load planning you did previously to insure that side #1 and side #2 of the transfer switch are balanced. Wire the circuits, starting with toggle Switch A.

If a selected circuit is part of a multi-wire branch circuit, insure the other branch circuit that shares the neutral is also connected to the transfer switch. The two circuits must be connected to opposing legs (phases) of the generator power and a handle tie must be installed on the switch handles so that both legs are transferred at the same time.

## WARNING Failure to properly install a multi-wire branch circuit could result in overloading the neutral wire.

If you will not be installing any 240 Volt or multi-wire circuits, remove the factory-installed handle tie(s) on the unit by loosening the setscrews on the tie.

Lets assume that, according to your load balancing plan, you will use Switch A to supply power to the refrigerator (Figure 5)

1. Turn off the refrigerator circuit breaker. Disconnect the wire that is attached to the circuit breaker.
2. Find the black and red wires from the transfer switch marked A.
3. Cut the red wire at a length convenient for it to reach to the refrigerator circuit breaker. Strip 5/8" from the end of the wire. Connect the red wire to the refrigerator circuit breaker and retighten the screw on the breaker.
4. Cut the black wire from the transfer switch to a length convenient for attaching it to the wire you removed from the refrigerator circuit breaker in #1. Strip 5/8" from the end of the wire.
5. Insert both wires—the one removed from the refrigerator circuit breaker and the black wire for Switch A—into a yellow wire connector. Tighten the connection and push the connected wires back into the wiring compartment of the load center.

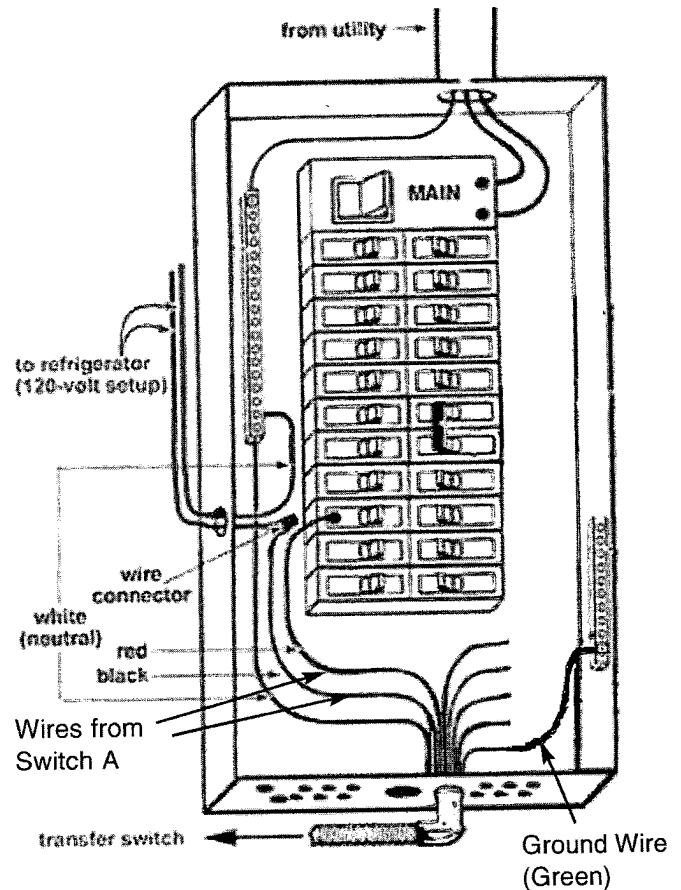

Figure 5

This completes the connection of Switch A for your refrigerator. Label Switch A as "REFRIGERATOR" on the identification pad on top of the transfer switch.

6. Repeat Steps 1 through 5 for each of the remaining switches on your transfer switch according to your load balancing plan, taking into account the following:
  - See the next section for installing 240-Volt Circuits
  - Remember to "Balance the Load", dividing appliances with higher wattages between the left and right side of the transfer switch

## E. Installing 240 Volt Circuits

Reliance Controls 6-Circuit Transfer switch (In Kit) is shipped from the factory with one installed handle tie on two adjacent circuits.

Let's assume that, according to your set-up plan, Switches C & D on the 6-Circuit transfer switch will be used to supply power to your well pump, a 240 Volt appliance. (Figure 6)

1. Find the two red and the two black wires marked C & D.
2. Turn off the double pole breaker for the well pump in the load center.
3. Disconnect the two installed wires on the double pole breaker.
4. Cut the two red wires from Switches C & D at a length convenient for them to reach to the double pole breaker. Strip 5/8" from the end of each red wire. Connect both red wires to the double pole circuit breaker in place of the wires you just removed from that breaker. It doesn't matter in what order.
5. Cut the black wires marked C & D to a length convenient to reach to the wires you removed from the double pole breaker in #3. Strip 5/8" from the end of each wire.
6. Connect one of the wires you removed from the double pole breaker in #3 with one of the black wires (either C or D) with a yellow wire connector. Similarly, connect the other wire you removed with the remaining black wire with a wire connector.

## F. Completing the Installation of the Transfer Switch

When you have wired all of the circuits from the transfer switch into your load center and have properly installed the green and white wires to ground the unit, you have finished the installation. (Figure 7) Just a few more steps to wrap things up.

1. Replace the cover of the load center.
2. If you have not already done so, fill in the chart on the top of the transfer switch to identify your emergency circuits and the toggle switches they correspond to.
3. Do not turn the main and individual circuit breakers in your load center back on until you have installed all other transfer switch components in Sections G, H and I which follow.



When Installing 240 Volt Circuits

The transfer switch circuits with 20 Amp breakers must be connected only to branch circuits with 20 Amp breakers in the load center. Do not connect transfer switch circuits to any branch circuits greater than 20 Amps.

NOTE: The transfer switch circuits with 15 Amp breakers can be connected to branch circuits with either 15 or 20 Amp breakers in the load center.

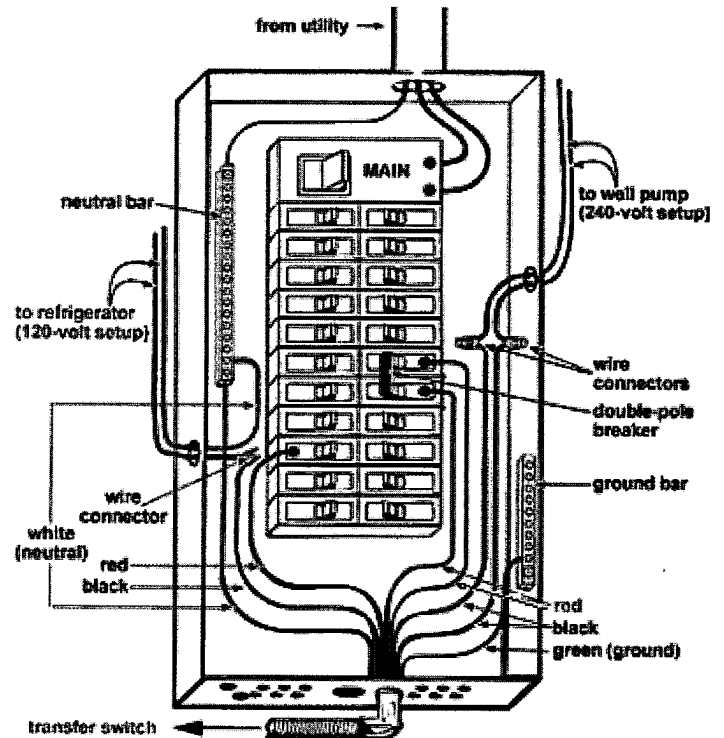

Figure 6

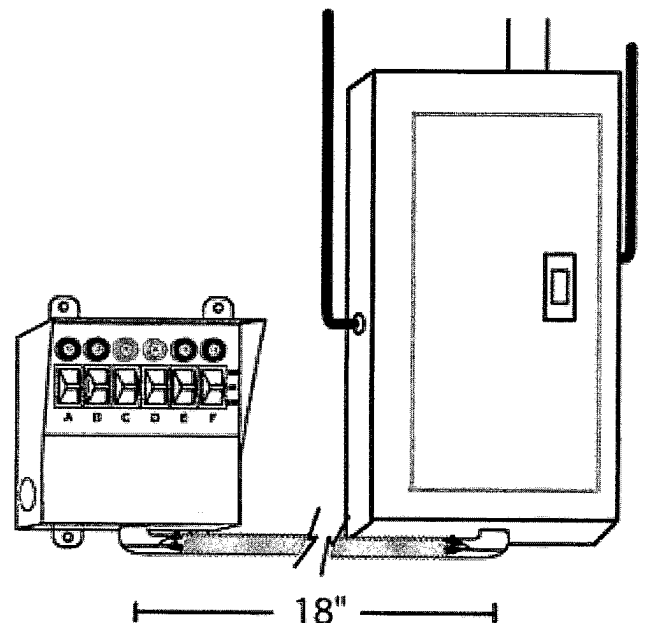

Figure 7

## G. Installing and Wiring the Outdoor Power Inlet Box (included in kit)

Since you will be operating your generator outdoors in a location remote from your electrical load center, it is recommended that you install an outdoor power inlet box on an exterior wall of your house. Because it is hardwired directly to your transfer switch, the power inlet box gives you the flexibility to locate your generator just about anywhere.

Reliance Controls Power Inlet Boxes are UL listed and can be used with the following generator and building wire sizes:

<u>Generator Size</u>	<u>Power Inlet Box</u>	<u>Building Wire (100' or less)</u>
Up to 7500 Watts	PB30 (In kit)	10 gauge

To install a Reliance Power Inlet Box (Figure 8):

1. Loosen the screw at the bottom front of the box and lift off the cover.
2. Choose which knockout hole on the box is most convenient to where you will be running the building wire into your house. Remove the knockout with a screwdriver and hammer.
3. Plan to run enough building wire (check electrical codes for the need for conduit) to reach your transfer switch, allowing extra length for ease of wiring at the transfer switch end.
4. Using approved wiring methods, place a cable or conduit connector (check codes) in the inlet box knockout hole and run enough building wire into the box to allow easy wiring. Tighten the connector.
5. Mount the back plate of the power inlet box where it will be convenient. Use the three holes in the plate.
6. Strip 5/8" from each building wire lead. Loosen the green grounding screw on the inside of the box and insert the stripped end of the building wire ground under one side of the grounding screw and retighten.
7. On the bottom of the inlet plug, insert the white wire into the hole marked "W" and tighten the screw on the side of the plug. Do the same with the red wire into the hole marked "X" and the black wire into the hole marked "Y".
8. Replace the cover of the power inlet box and tighten the screw.

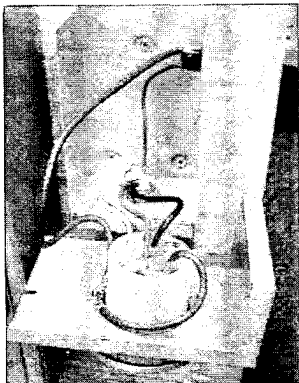

Figure 8

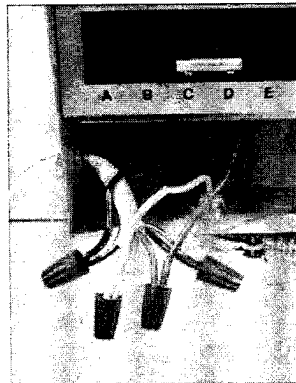

Figure 9A

## H. Wiring the Power Inlet Box to the Transfer Switch

All Reliance Controls transfer switches are designed to allow hardwiring between the outdoor power inlet box and the transfer switch's internal wiring compartment. This installation is the most efficient, eliminates the need for longer generator power cords running through your home to your transfer switch and eliminates the need for an additional junction box.

To hardwire your transfer switch to the building wire from the power inlet box (Figure 9A and 9B):

1. Remove the front bottom wiring compartment cover plate of the transfer switch by unscrewing the two screws securing the plate and then pulling out on the bottom of the plate. Once the plate is removed, the wire leads necessary to connect the incoming building wire can be easily accessed.
2. Punch out the knockout hole on the side of the transfer switch wiring compartment.
3. Using approved wiring methods, place a cable or conduit connector (check electrical codes) in the knockout hole, and pull enough building wire into the inside of the wiring compartment to provide sufficient working length. Tighten the connector.
4. Connecting the Wattmeters: Thread the black building wire through the transformer ring attached to the left wattmeter before connecting it to the black transfer switch wire. Likewise thread the red building wire through the transformer ring attached to the right wattmeter before connecting it to the red transfer switch wire. Connect the green and white to white wires with a red connector. Do not thread these wires through the transformer rings (Figure 9B).
5. Complete the wiring by pushing the wires back into the unit, putting the wiring compartment cover back in place and replacing the screws that hold the cover plate.

### Connecting the Wattmeters

Black wire through left ring transformer      Red wire through right ring transformer

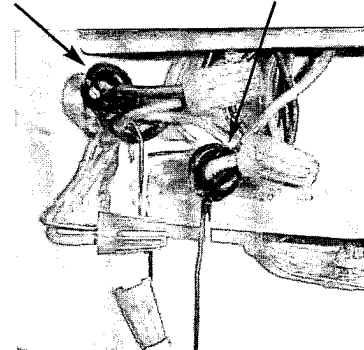

Figure 9B

## I. Installing an Optional Power Inlet on your Transfer Switch (not necessary in kit installation)

Although such an installation is not necessary with the Power Transfer Kit, your Reliance Controls transfer switch is unique in that it allows the installation of an accessory power inlet which allows you to plug your generator directly into your transfer switch using a longer power cord. This may be convenient under certain circumstances and is explained here.

To install a power inlet on your transfer switch (Figures 10A-10C):

1. Purchase Reliance Flanged Power Inlet model number L1420F for a 20 Amp inlet to accommodate 20 Amp power cords and small generators up to 5000 watts, or L1430F for a 30 Amp inlet to accommodate 30 Amp power cords and generators up to 7500 watts. If you choose to, you may also use the 30 Amp power Inlet from the Reliance PB30 Power Inlet Box (supplied with the kit).
2. Remove the plastic Reliance logo panel located on the right side of the wiring compartment cover to reveal the hole for the power inlet. One screw holds this plate on the bottom.
3. Remove the entire wiring compartment plate by removing the other bottom screw and pulling out on the bottom of the plate.
4. If your transfer switch has wattmeters, make sure that the black wire from the transfer switch is threaded through the transformer ring connected to the left wattmeter, and the red wire from the transfer switch is threaded through the transformer ring connected to the right wattmeter.
5. Insert the power inlet into the hole in the wiring compartment plate and fasten it with the two smaller screws included with the inlet. Do not refasten the longer bottom screw at this time.
6. On the underside of the inlet, insert the white wire into the hole marked "W" and tighten the screw on the side of the plug. Do the same with the red wire into the hole marked "X", the black wire into the hole marked "Y" and the green wire into the hole marked "G".
7. Replace the wiring compartment panel with the two screws you removed in steps #2 and #3, inserting the longer screw through the bottom of the flanged inlet plug.

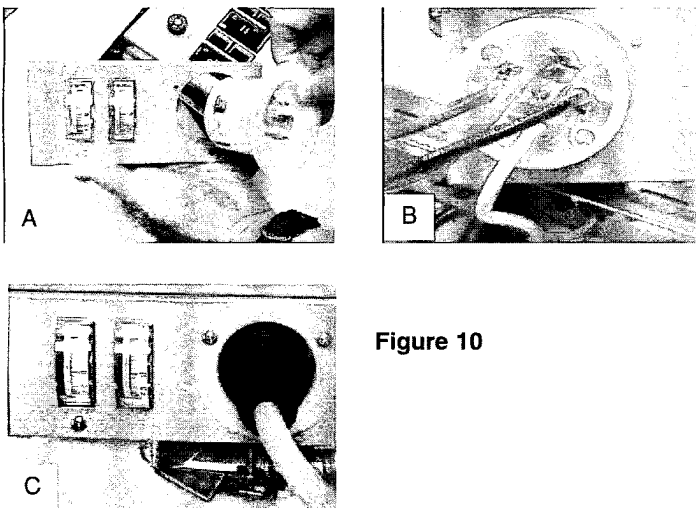

Figure 10

## J. Finishing Up

According to your individual installation requirements, after you have completed all the steps necessary in Sections G through I, complete the system installation by doing the following:

1. Turn on all of the circuit breakers in your load center.
2. Turn on the main breaker.
3. Position all switches on the transfer switch to the LINE position.
4. **IMPORTANT!** In order to insure that all wiring connections have been properly completed and that your system functions properly under generator power, it is important to test each circuit before turning on any devices or appliances connected to that circuit. Correct voltage output can and should be checked with a voltage meter at any convenient electrical outlet on each branch circuit that is wired through the transfer switch. This should be done under generator power with the appropriate circuit breaker switch in the "GEN" position.

### OPERATING INSTRUCTIONS



#### WARNING

Do not operate your generator in an enclosed area.

You want your generator to be ready when you need it – so, it is important to perform the following steps once a month:

- Start and run generator power through your transfer switch circuits.
- Keep your fuel tank filled with fresh fuel.

With your Reliance Controls transfer switch installed, it is not necessary to turn off any of your load center breakers when starting your generator, even when utility power is fully functional. This is because the double throw break-before-make action of the transfer switch prevents feeding generator power to the utility and, conversely, prevents feeding utility power back to your generator.

### A. Transferring from Utility Power to Generator Power in an Emergency

1. Make sure that all switches on the Reliance Controls transfer switch are in the LINE position.
2. Plug the male end of your power cord into the generator. NOTE: If your generator has only 20 Amp 125/250 V output receptacles, replace the 30 Amp male end of the power cord with the 20 Amp male plug end supplied in the kit. See installation instructions with the 20 Amp plug.
3. Plug the female end of your power cord into either the outdoor power inlet box or directly into the transfer switch, depending on how you installed your system.
4. Start your generator outdoors and let it warm to a point where it is running evenly.
5. Turn the toggle switches on your Reliance transfer switch to the GEN position one at a time.

If you have a Reliance transfer switch with wattmeters, you can monitor the wattage load on your generator.

### B. Transferring back to Utility Power When the Power Is Restored

1. Move all switches on the Reliance Controls transfer switch back to the LINE position.
2. Turn off your generator.
3. Unplug your power cord and store it.

## TRANSFER SWITCH PRODUCT SPECIFICATIONS

Maximum Watts	7500
Possible Single Pole/Double Pole Combinations	0-1 DP / 4-6 SP
Maximum Combined Load @ 125 Volts AC (Amps)	60 Amps
Maximum Combined Load @ 250 Volts AC (Amps)	30 Amps
Maximum Load per Circuit from Generator (Amps)	(2) 20, (4) 15
Maximum Load per circuit from Load Center (Amps)	20
Recommended Building Wire Size (runs less than 100')	10 Gauge with ground
Wattmeters	Yes
Number of Knockouts Available 1/2" or 3/4"	6
Power Inlet Box Match	PB30
Cabinet Dimensions H x W x D (inches)	7 1/2" x 7" x 4 1/2"
Cabinet Type (NEMA)	1

## TRANSFER SWITCH ACCESSORIES AVAILABLE FROM RELIANCE CONTROLS

**These additional products are available through your local distributor.  
Call Reliance Controls at (800) 634-6155 to locate the distributor nearest you.**

### Power Cords

Connect generator power outlets with outdoor power inlet boxes or accessory power inlets

PC2010	10-foot cord with L14-20P and 14-20R twist lock ends
PC2020	20-foot cord with L14-20P and 14-20R twist lock ends
PC3010	10-foot cord with L14-30P and 14-30R twist lock ends
PC3020	20-foot cord with L14-30P and 14-30R twist lock ends

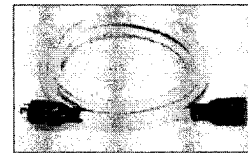

Power Cords

### Transfer Switch Accessory Power Inlets

Insert into faceplate of transfer switch wiring compartment to allow plug-in of power cords directly to transfer switches

L1420F	20 Amp power inlet
L1430F	30 Amp power inlet

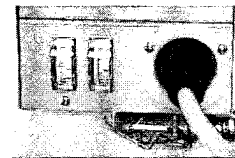

Accessory Power Inlets

### Flush-Mount Kit

Use with Reliance surface-mount transfer switch (supplied in kit) to convert to a flush-mount installation

KF6	For 6-Circuit Transfer Switch
-----	-------------------------------

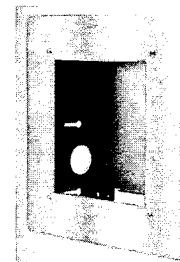

Flush Mount Kit

## SUPPLEMENTAL INSTALLATION AND OPERATING INSTRUCTIONS FOR 31410CRK

### PARTS LIST FOR 31410CRK:

30 Amp 10-Circuit Transfer Switch  
30 Amp Outdoor Power Inlet Box  
30 Amp 10-Foot long Generator Power Cord  
20 Amp Power Cord Plug  
4 Red and 10 Yellow Wire Connectors

### INSTALLATION AND OPERATING INSTRUCTIONS

Follow the Installation and Operating Instructions for the 31406CRK. Note that in the section entitled "Installing 240 Volt Circuits" on Page 8, that the 10-Circuit unit has two factory-installed handle ties for two 240 Volt circuits. Handle ties can be added to get up to 5 double-pole circuits or removed to have none. Adjacent circuits that can be handled tied together are A & F, B & G, C & H, D & I, and E & J.

### TRANSFER SWITCH SPECIFICATIONS

Maximum Watts	7500
Possible Single Pole/Double Pole Combinations	0-5 DP / 0-10 SP
Maximum Combined Load @ 125 Volts AC	60 Amps
Maximum Combined Load @ 250 Volts AC	30 Amps
Maximum Load per Circuit from Generator (Amps)	(4)20, (6)15
Maximum Load per Circuit from Load Center (Amps)	20 All Circuits
Recommended Building Wire Size (Runs less than 100 feet)	AWG 10 w/ground
Watt Meters	Yes
Number of Knockouts Available 1/2" or 3/4"	6
Power Inlet Box Match	PB30
Cabinet Dimensions H x W x D (Inches)	13 3/4 x 7 x 4 1/2
Cabinet Type (NEMA)	1



RELIANCE CONTROLS CORPORATION / 2001 YOUNG CT. /  
RACINE, WI 53404 / (262-634-6155)

### Five Year Limited Warranty

Reliance Controls Corporation ("Reliance") warrants this Protran® Manual Transfer Switch ("Switch") to be free from failure to perform as intended due to defects in materials and workmanship for a period of five (5) years from date of manufacture, provided the Switch has been installed and used in accordance with manufacturer's instructions and has not been subjected to misuse, alteration, accident, or repair not performed by Reliance. If, within such warranty period, the original purchaser gives written notice to Reliance at the address shown below and the Switch has been proven to Reliance's reasonable satisfaction to be defective, then Reliance at its sole option shall either: (i) supply a replacement component(s) for the defective component(s) or (ii) repair or replace the Switch. Reliance's obligation is strictly limited to said repair or replacement of the Switch, and Reliance shall not be liable for any incidental, special or consequential damages. The cost of labor to remove or install a replacement component or Switch is not included in this warranty. The foregoing warranty is exclusive and in lieu of all other expressed or implied warranties, if any, including but not limited to implied warranties of merchantability and fitness for a particular purpose. Reliance strongly recommends that the purchaser seek the advice of a licensed electrician to determine the suitability of this product, and for its proper installation in accordance with all applicable state and local building codes. This warranty gives you specific legal rights, and you may have other rights which vary from state to state.

Reliance Controls Corporation  
2001 Young Court  
Racine, WI 53404  
Attn: Warranty Claims Department

Attach Your Purchase  
Receipt Here for Your  
Records

Cut Here and Fold to Create Self Mailer for Warranty Registration

## Warranty Registration

Return within 30 days of purchase. Please answer these few questions for our records, cut on dotted line above, fold with Reliance Controls address on the outside of the mailer and staple. Thank you.

First Name: \_\_\_\_\_

Last Name: \_\_\_\_\_

Address: \_\_\_\_\_

City, State, Zip: \_\_\_\_\_

Phone: \_\_\_\_\_

Email: \_\_\_\_\_

Purchase Date: \_\_\_\_\_ Purchase Price: \_\_\_\_\_ Name of Store: \_\_\_\_\_

Are you: \_\_\_\_\_ a professional installer \_\_\_\_\_ a do-it-yourself installer

Please call us anytime at (800) 439-5745 with your comments or questions. Thank you.

# HOME CIRCUIT MAPPING CHART

<i>This Toggle Switch on My Generator Transfer Switch</i>						
	<b>A</b>	<b>B</b>	<b>C</b>	<b>D</b>	<b>E</b>	<b>F</b>
<i>Controls these essential appliances I will need during a power outage</i>						
<i>So, I need to turn off these other devices which are on the same Circuits</i>						

**AFFIX  
POSTAGE  
HERE**

**Reliance Controls Corporation**  
**2001 Young Court**  
**Racine, WI 53404**

STAPLE



**Reliance Controls Customer Service: (800) 439-5745**  
**Website: [www.reliancecontrols.com](http://www.reliancecontrols.com)**

12/4/09